



Coaxial Attenuator

Features and Electrical specifications:

Model	ATXXFA200A-N-6			
Frequency Range	DC-6.0GHz			
VSWR	1.30Max			
Power	200 W			
Impedance	50 Ω			
Attenuation	01-10dB	11-20dB	21-40dB	50dB
Attenuation Tolerance	± 1.0 dB	± 1.2 dB	± 1.3 dB	± 1.4 dB
Connector	N-J(M)/N-K(F)			
Dimension	78 \times 80 \times 262.1mm			
Operating Temperature	-55 ~ +125 $^{\circ}$ C (See de Power De-rating)			
Weight	About 1.8 Kg			
ROHS Compliant	Yes			

Outline Drawing (Unit: mm/inch):

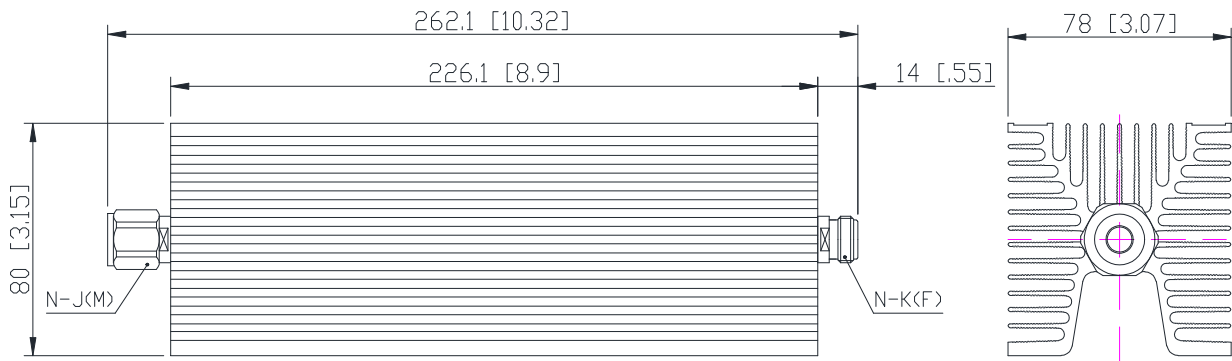
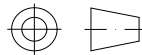



Naming rules:

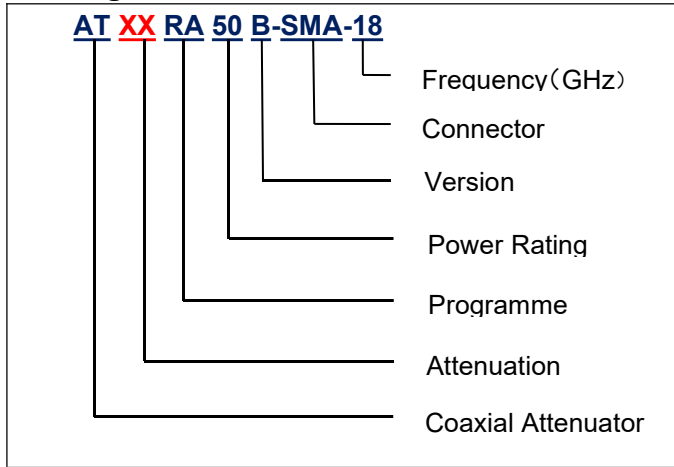

Power De-rating:

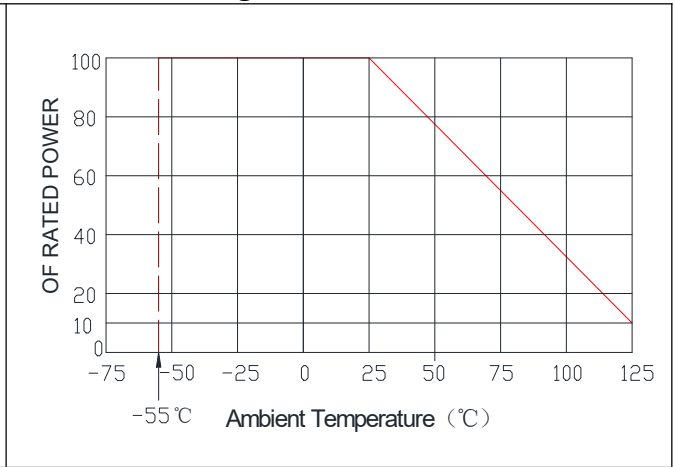

**Graph:
6dB**

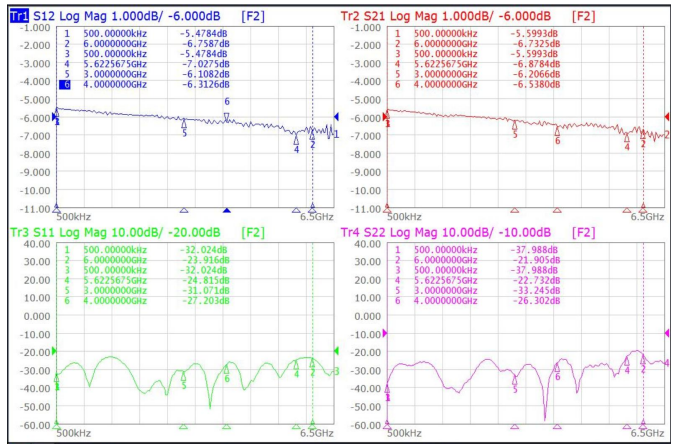

30dB

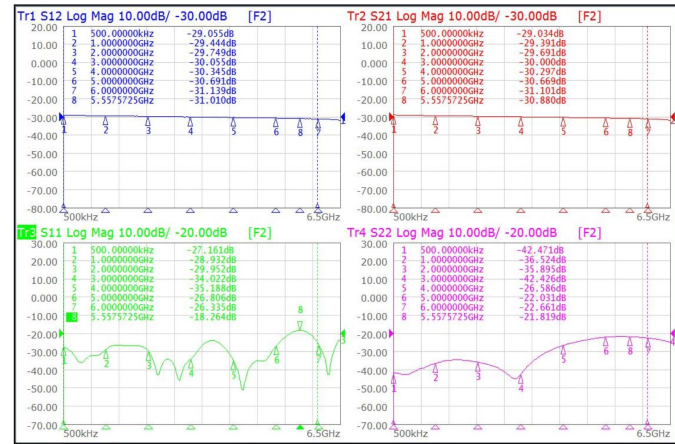

40dB

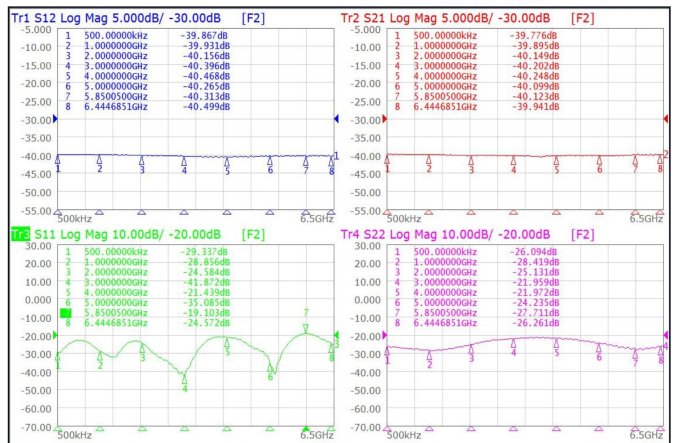

50dB

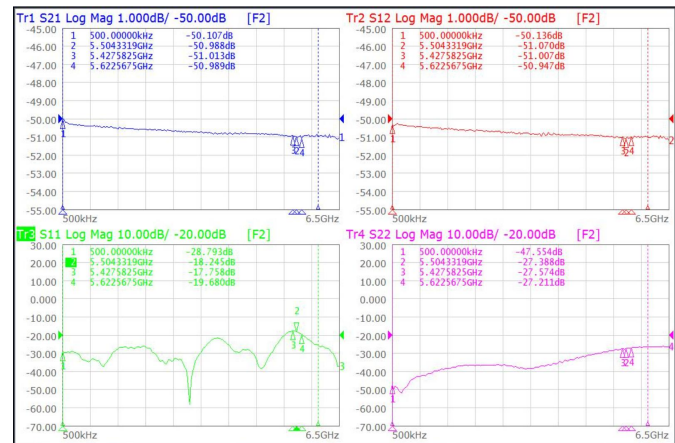



Use attention:

- 1、 Dimensions Tolerance $\pm 3\%$;
- 2、 If necessary, the product shall be air-cooled for auxiliary heat dissipation ;
- 3、 Custom designs available of other special attenuators ;
- 4、 Pay attention to the direction of the product during use and strictly prohibit reverse connection。