



Coaxial Attenuator

Features and Electrical specifications:

Model	ATXXRA200A-NK-6			
Frequency Range	DC-6.0GHz			
VSWR	1.30Max			
Power	200 W			
Impedance	50 Ω			
Attenuation	01-10dB	11-20dB	30、40dB	50、60dB
Attenuation Tolerance	±1.0dB	±1.2dB	±1.3dB	±1.4dB
Connector	N-K(F)/N-K(F)			
Dimension	Φ40.0×254.5mm			
Operating Temperature	-55 ~ +125°C (See de Power De-rating)			
Weight	About 860 g			
ROHS Compliant	Yes			

Outline Drawing (Unit: mm/inch):

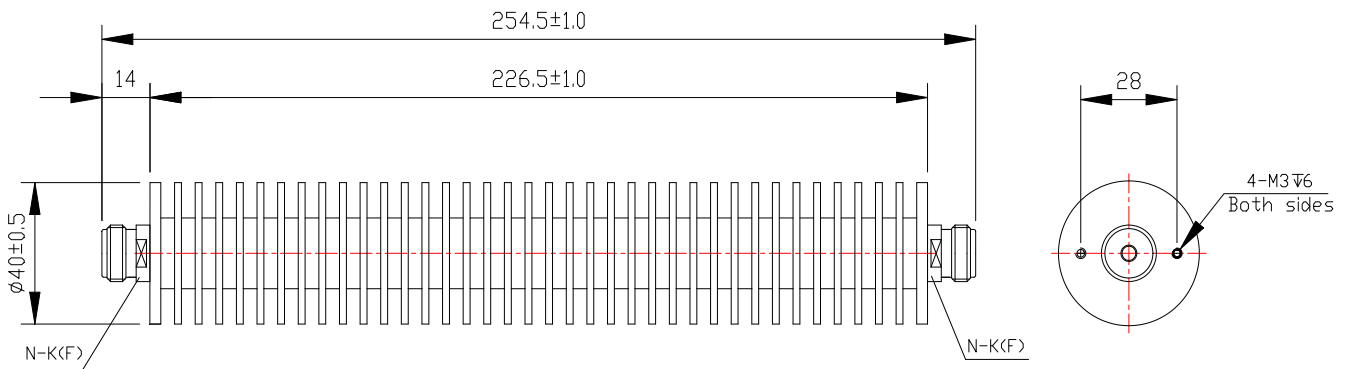
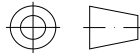

此产品必需对产品进行风冷辅助散热,风机推荐选用 0.625 m³/S

RFTYT Technology Co., LTD.

<http://www.rftyt.com>

E-mail: Jackson@rftyt.com zqc7708@rftyt.com

TEL: +86-13088268828 FAX: +86-816-2846565

218# Wenwu Middle Road, Jinkai District, Mianyang, Sichuan Province China

Ready For Tackling Your Trouble



Naming rules:

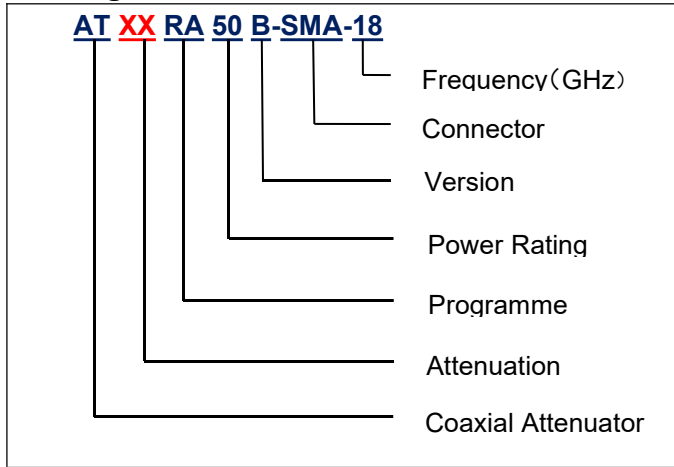

Power De-rating:

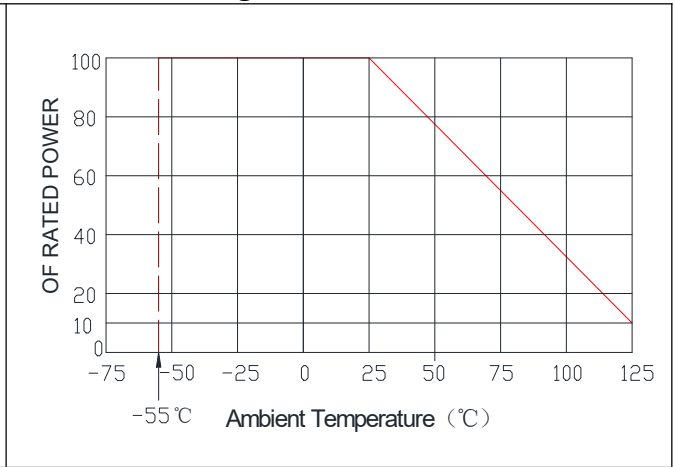

**Graph:
6dB**

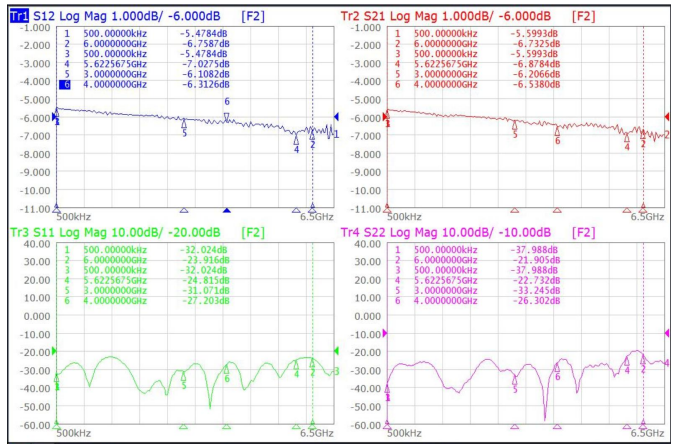

30dB

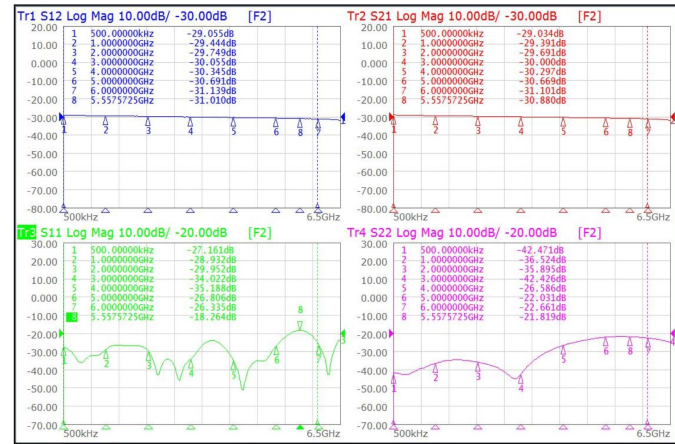

40dB

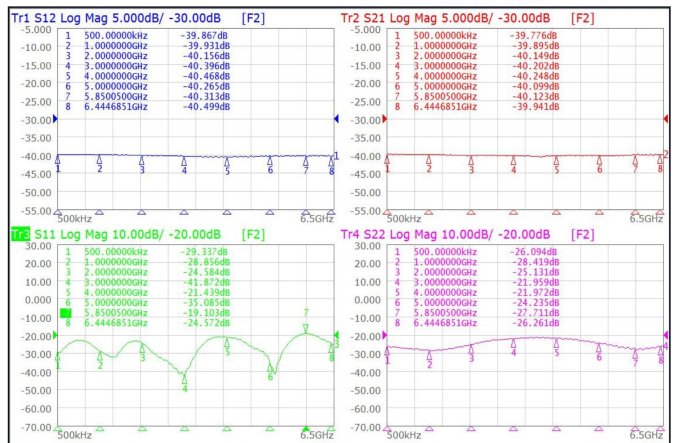

50dB

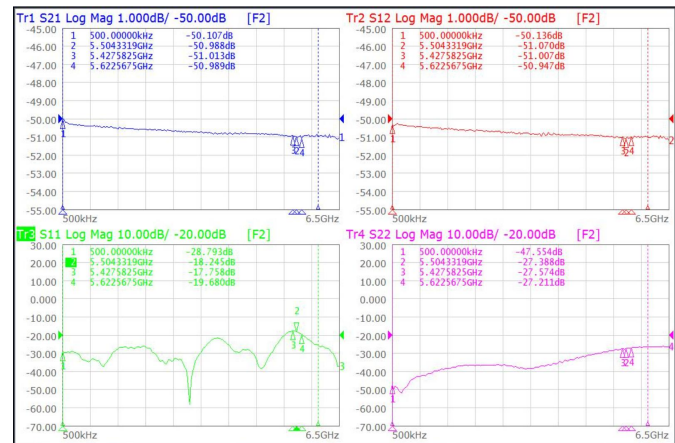



Use attention:

- 1、 Dimensions Tolerance $\pm 3\%$;
- 2、 If necessary, the product shall be air-cooled for auxiliary heat dissipation ;
- 3、 Custom designs available of other special attenuators ;
- 4、 Pay attention to the direction of the product during use and strictly prohibit reverse connection。