



## Coaxial Attenuator

### Features and Electrical specifications:

Model	ATXXRA300A-NK-6			
Frequency Range	DC-6.0GHz			
VSWR	1.30Max			
Power	300 W			
Impedance	50 $\Omega$			
Attenuation	01-10dB	11-20dB	30、40dB	50、60dB
Attenuation Tolerance	$\pm 1.0$ dB	$\pm 1.2$ dB	$\pm 1.3$ dB	$\pm 1.4$ dB
Connector	N-K(F)/N-K(F)			
Dimension	$\Phi 50.0 \times 310$ mm			
Operating Temperature	-55 ~ +125°C (See de Power De-rating)			
Weight	About 1.4Kg			
ROHS Compliant	Yes			

### Outline Drawing (Unit: mm/inch):

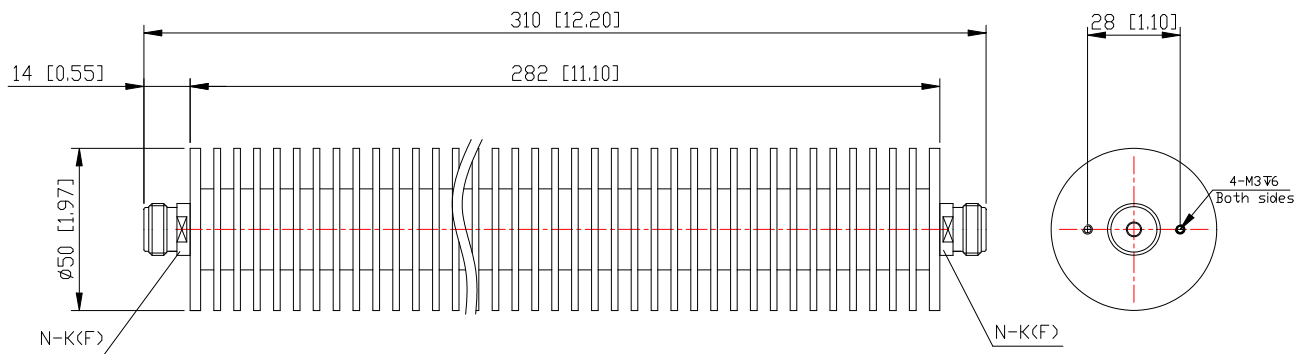
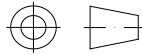

此产品必需对产品进行风冷辅助散热,风机推荐选用 0.625 m<sup>3</sup>/S

**RFTYT Technology Co., LTD.**

<http://www.rfyt.com>

E-mail: Jackson@rfyt.com      zqc7708@rfyt.com

TEL: +86-13088268828      FAX: +86-816-2846565

218# Wenwu Middle Road, Jinkai District, Mianyang, Sichuan Province China

**Ready For Tackling Your Trouble**



**Naming rules:**

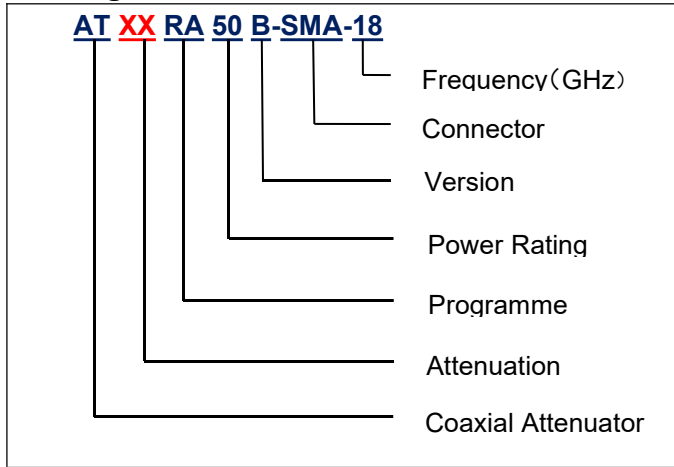

**Power De-rating:**

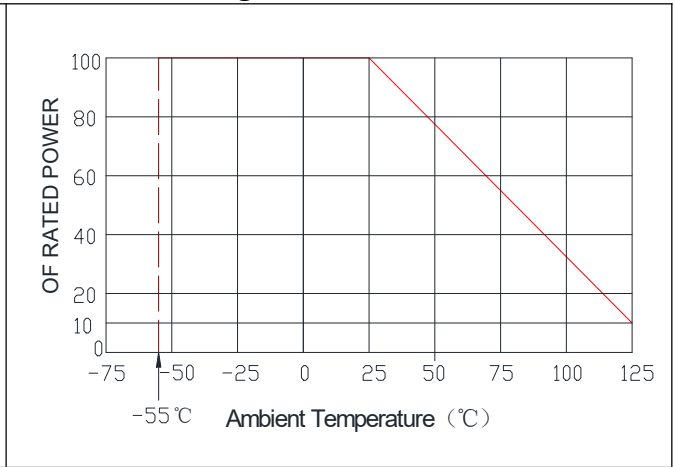

**Graph: 6dB**

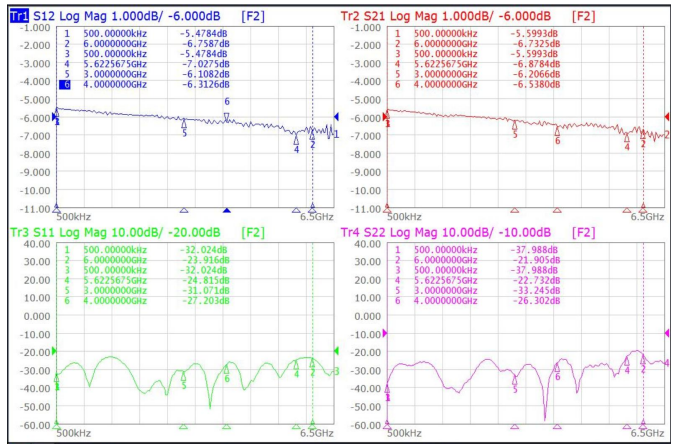

**30dB**

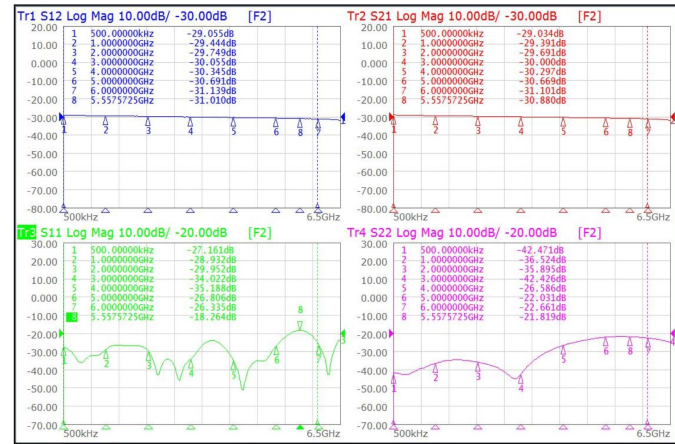

**40dB**

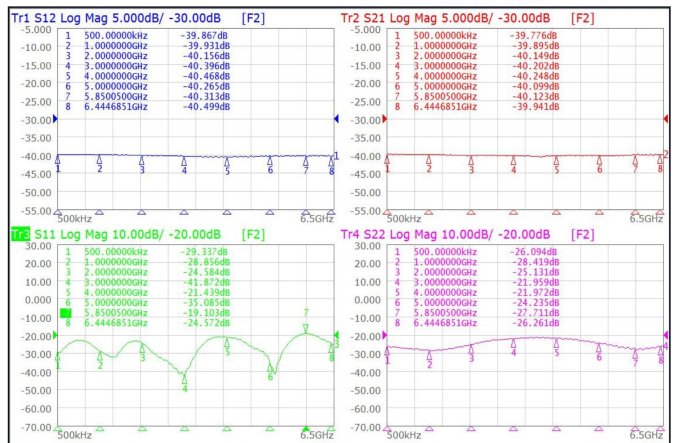

**50dB**

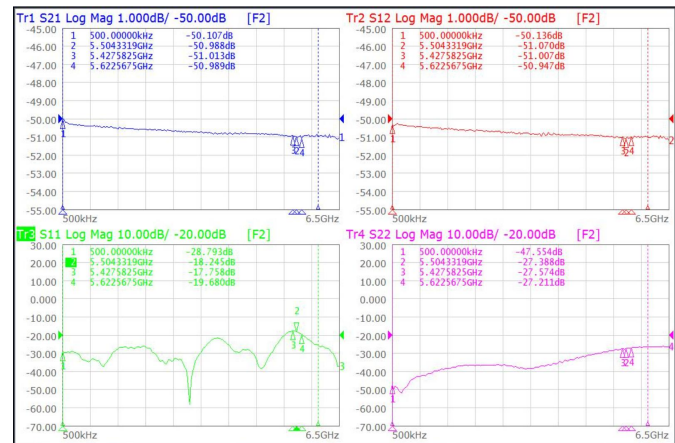



**Use attention:**

- 1、 Dimensions Tolerance  $\pm 3\%$ ;
- 2、 If necessary, the product shall be air-cooled for auxiliary heat dissipation ;
- 3、 Custom designs available of other special attenuators ;
- 4、 Pay attention to the direction of the product during use and strictly prohibit reverse connection。