



## Coaxial Attenuator

### Features and Electrical specifications:

Model	ATXXRA02A-1.85-67		
Frequency Range	DC~67.0GHz		
VSWR	1.35 Max		
Power	2 W		
Impedance	50 Ω		
Attenuation	1-10dB	20dB	30dB
Attenuation Tolerance	-1.0 dB /+1.2 dB	-1.2dB /+1.2 dB	-1.5dB /+1.5 dB
Connector	1.85-J(M)/1.85-K(F)		
Dimension	Φ9×18.5mm		
Operating Temperature	-55 ~ +125°C (See de Power De-rating)		
Weight	About 4 g		
ROHS Compliant	Yes		

### Outline Drawing (Unit: mm/inch):

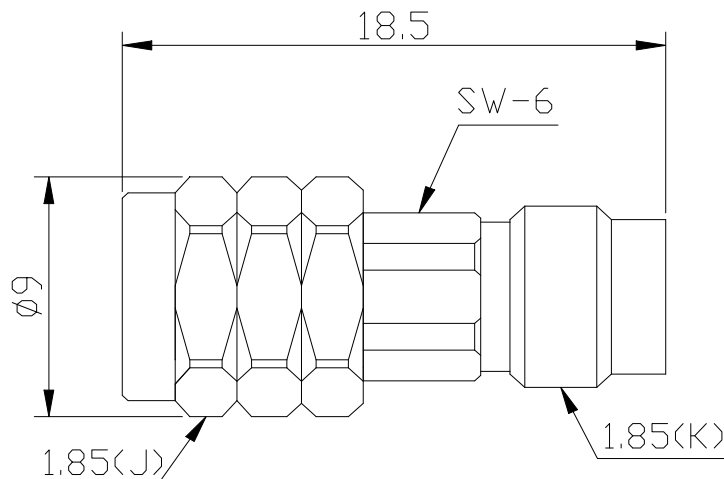



**Naming rules:**



**Power De-rating:**

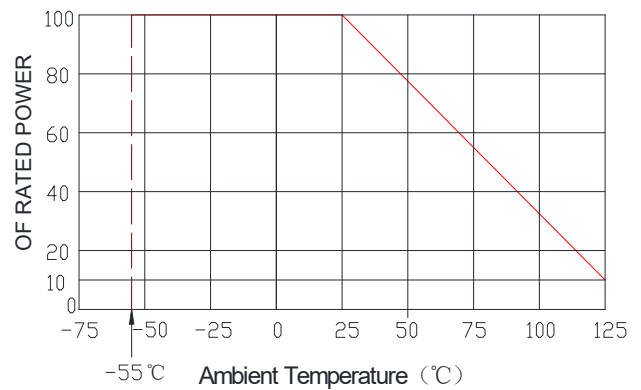

**Use attention:**

- 1、 Dimensions Tolerance  $\pm 3\%$ ;
- 2、 If necessary, the product shall be air-cooled for auxiliary heat dissipation ;
- 3、 Custom designs available of other special attenuators ;
- 4、 Pay attention to the direction of the product during use and strictly prohibit reverse connection。