



Coaxial Attenuator

Features and Electrical specifications:

Model	ATXXRA30A-SMA-6			
Frequency Range	DC~6.0GHz			
VSWR	1.25Max			
Power	30 W			
Impedance	50 Ω			
Attenuation	01-10dB	11-20dB	30、40dB	50、60dB
Attenuation Tolerance	±0.6dB	±0.8dB	±1.0dB	±1.2dB
Connector	SMA-J(M)/SMA-K(F)			
Dimension	Φ38x88.2mm mm			
Operating Temperature	-55 ~ +125°C (See de Power De-rating)			
Weight	About 160 g			
ROHS Compliant	Yes			

Outline Drawing (Unit: mm/inch):

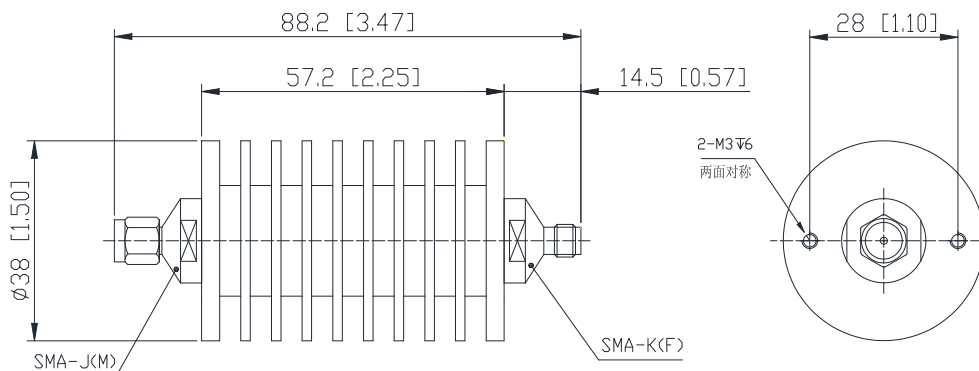
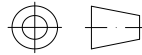



Naming rules:



Power De-rating:

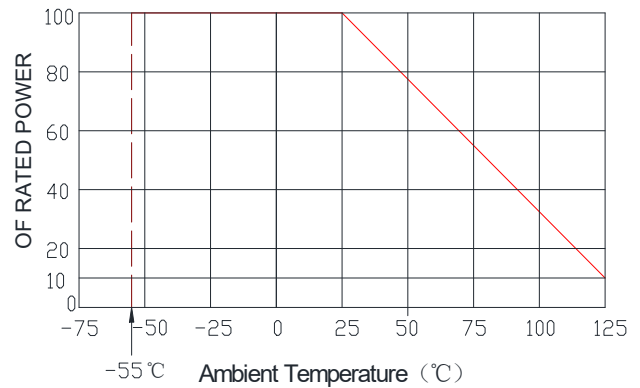

Use attention:

- 1、 Dimensions Tolerance $\pm 3\%$;
- 2、 If necessary, the product shall be air-cooled for auxiliary heat dissipation ;
- 3、 Custom designs available of other special attenuators ;
- 4、 Pay attention to the direction of the product during use and strictly prohibit reverse connection。