



Coaxial Attenuator

Features and Electrical specifications:

Model	ATXXRA100C-N-18
Frequency Range	DC-18.0GHz
VSWR	1.45Max
Power	100 W
Impedance	50 Ω
Attenuation	10、20、30、40、50dB
Attenuation Tolerance	-1.5dB/+2.5dB
Connector	N-J(M)/N-K(F)
Dimension	Φ60.0*198.9 mm
Operating Temperature	-55 ~ +125°C (See de Power De-rating)
Weight	About 600 g
ROHS Compliant	Yes

Outline Drawing (Unit: mm/inch):

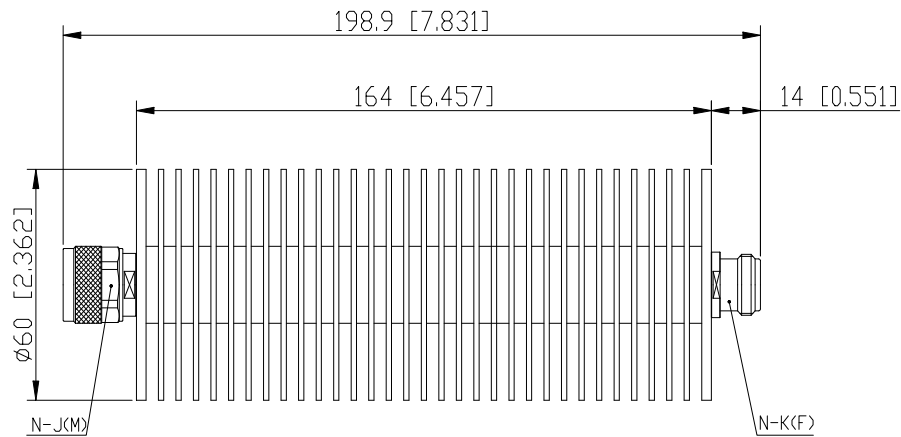
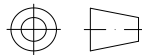

RFTYT Technology Co., LTD.

<http://www.rftyt.com>

E-mail: Jackson@rftyt.com zqc7708@rftyt.com

TEL: +86-13088268828 FAX: +86-816-2846565

218# Wenwu Middle Road, Jinkai District, Mianyang, Sichuan Province China

Ready For Tackling Your Trouble



Naming rules:

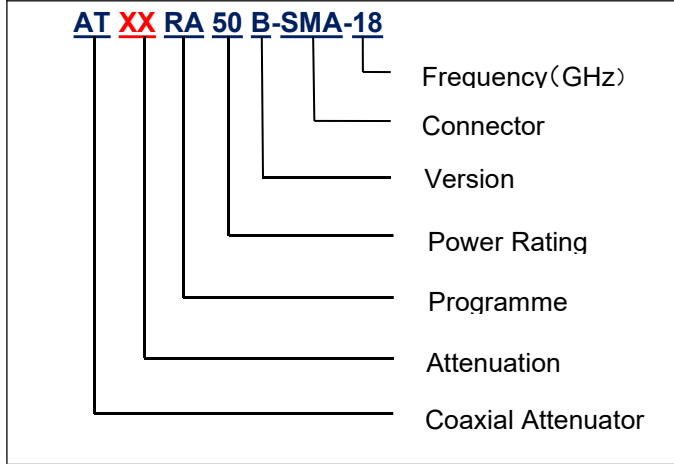

Power De-rating:

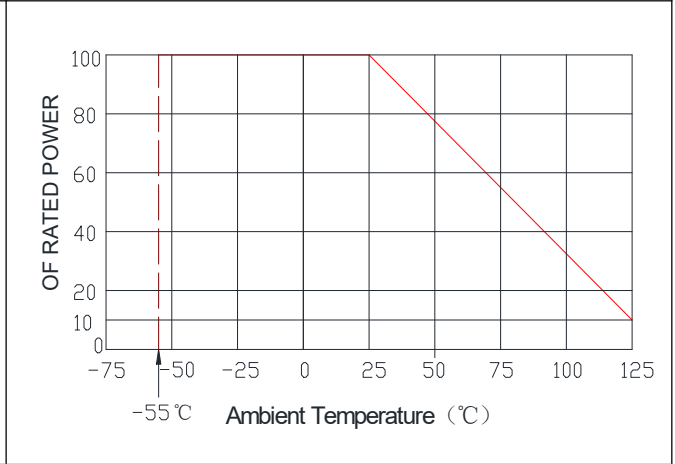

**Graph:
20dB**

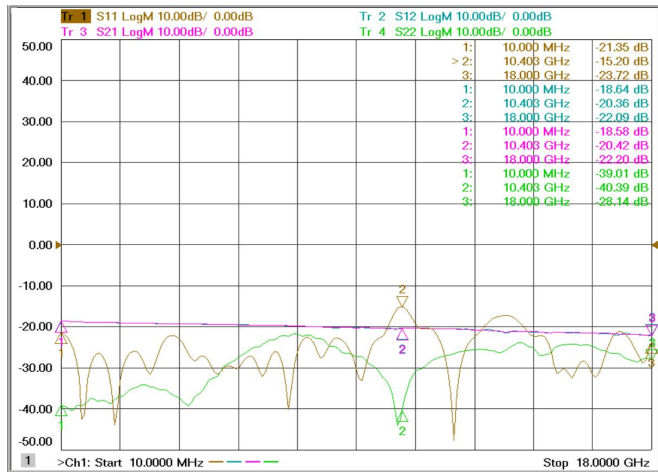

30dB

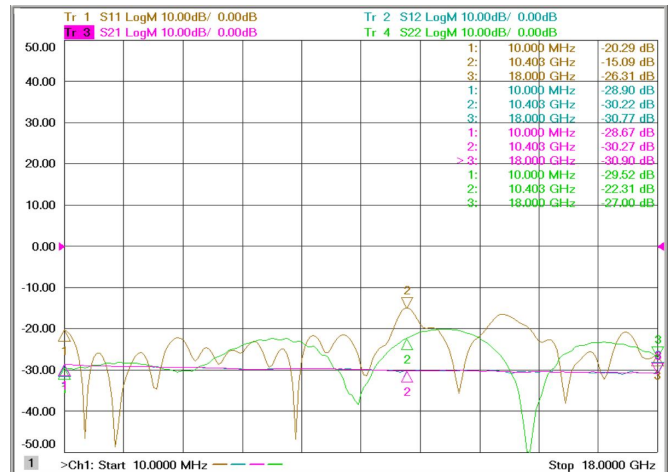

40dB

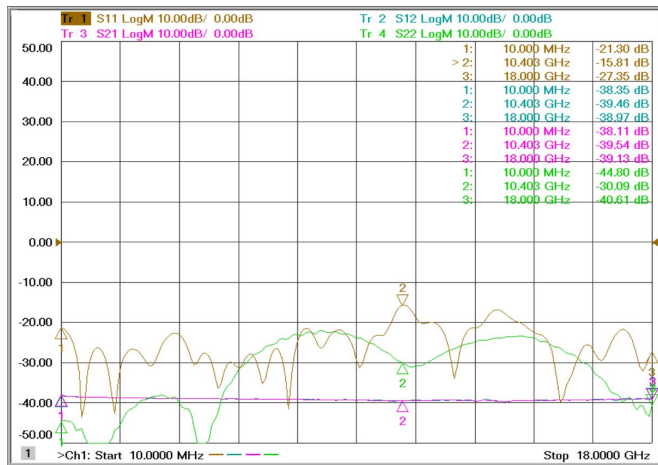

50dB

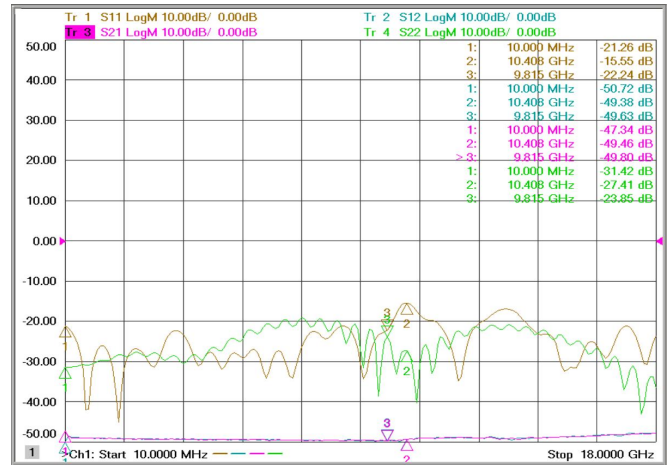



Use attention:

- 1、 Dimensions Tolerance $\pm 3\%$;
- 2、 If necessary, the product shall be air-cooled for auxiliary heat dissipation ;
- 3、 Custom designs available of other special attenuators ;
- 4、 Pay attention to the direction of the product during use and strictly prohibit reverse connection。