



Coaxial Attenuator

Features and Electrical specifications:

Model	ATXXRA10A-2.92-40		
Frequency Range	DC~40.0GHz		
VSWR	1.25Max		
Power	10 W		
Impedance	50 Ω		
Attenuation	1-10dB	20dB	30dB
Attenuation Tolerance	-0.6dB /+1.0dB	-0.8dB /+1.0dB	-0.8dB /+1.0dB
Connector	2.92-J(M)/2.92-K(F)		
Dimension	Φ 31.8×39.6mm		
Operating Temperature	-55 ~ +125°C (See de Power De-rating)		
Weight	About 30 g		
ROHS Compliant	Yes		

Outline Drawing (Unit: mm/inch):

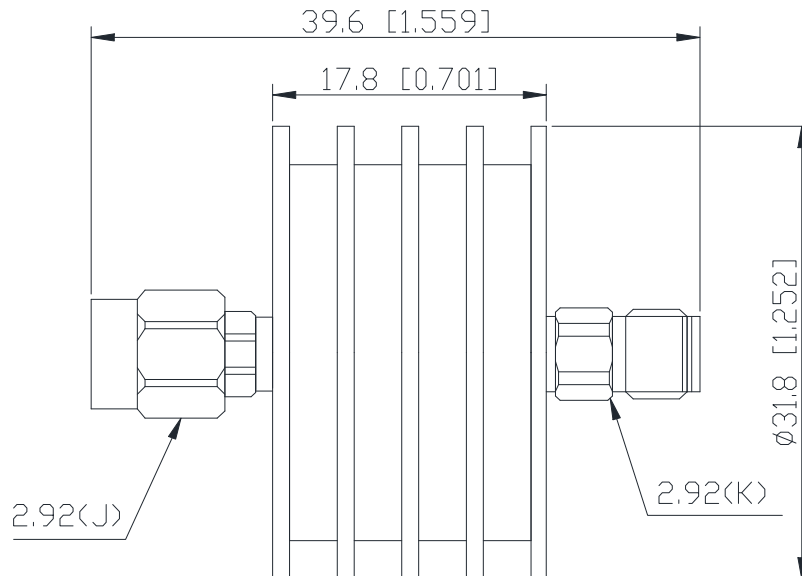
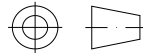

RFTYT Technology Co., LTD.

<http://www.rfyt.com>

E-mail: Jackson@rfyt.com zqc7708@rfyt.com

TEL: +86-13088268828 FAX: +86-816-2846565

218# Wenwu Middle Road, Jinkai District, Mianyang, Sichuan Province China

Ready For Tackling Your Trouble



Naming rules:



Power De-rating:



Use attention:

- 1、 Dimensions Tolerance $\pm 3\%$;
- 2、 If necessary, the product shall be air-cooled for auxiliary heat dissipation ;
- 3、 Custom designs available of other special attenuators ;
- 4、 Pay attention to the direction of the product during use and strictly prohibit reverse connection。