



Chip Resistor

Features and Electrical specifications:

Model	RFTXX-20CR2550W
Power	20 W
Resistance	XX Ω (10~3000 Ω Customizable)
Resistance Tolerance	$\pm 5\%$
Temperature Coefficient	<150ppm/ $^{\circ}\text{C}$
Substrate	BeO
Resistive Element	Thick Film
Operating Temperature	-55 to +150 $^{\circ}\text{C}$ (See de Power De-rating)

Outline Drawing (Unit: mm) :

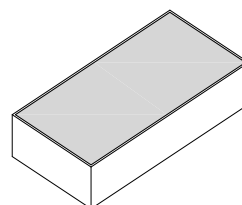
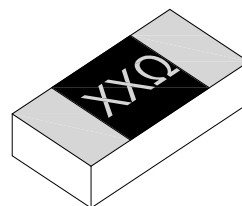
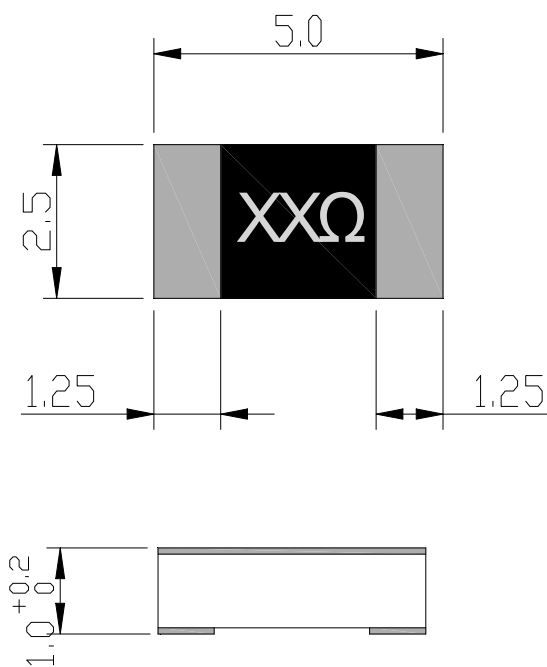
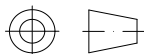



Suggested mounting procedures:

Power De-rating:

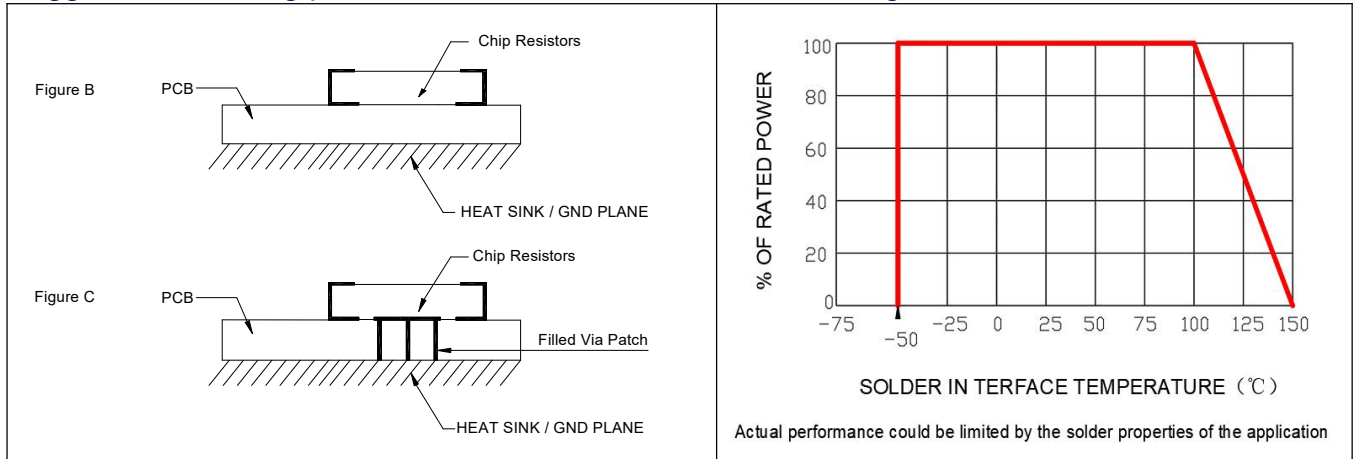

Reflow Profile:

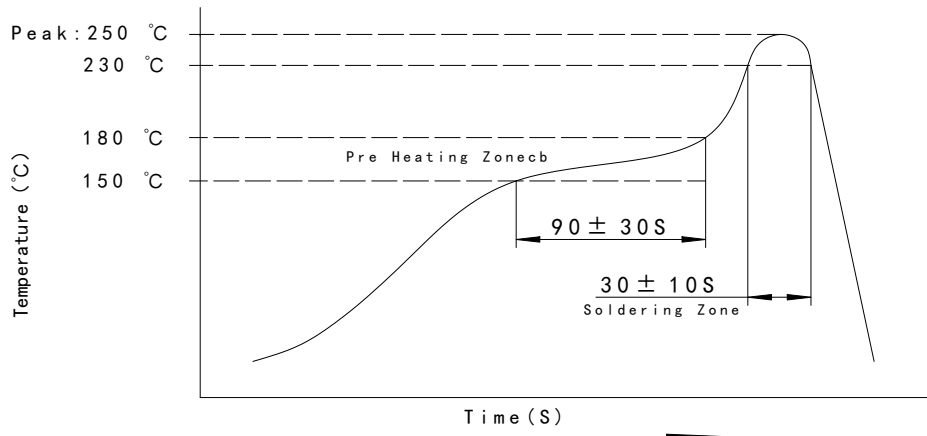

P/N Designation:

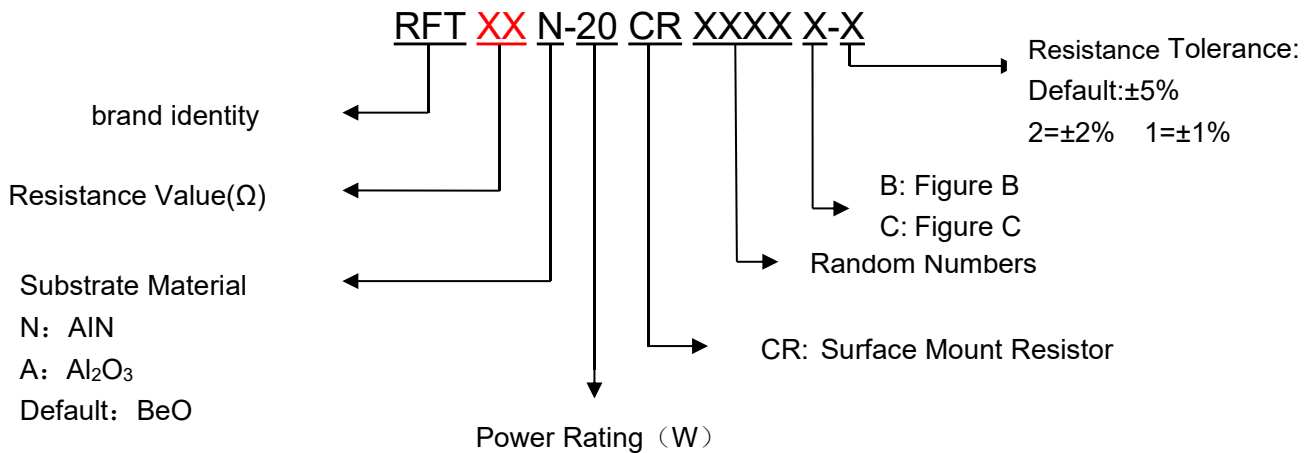



Use attention:

- After the storage period of newly purchased parts exceeds 6 months, attention shall be paid to the weldability before use. It is recommended to store after vacuum packaging.
- Drill thermal vias through PCB and fill with solder.
- Reflow welding is preferred for welding, see Reflow curve
- In order to meet the requirements of the drawing, a radiator of sufficient size must be installed.
- If necessary, add air cooling or water cooling.

Explain:

- Custom designs available RF Attenuators and RF Resistors and RF Terminations.