



## Coaxial Attenuator

### Features and Electrical specifications:

Model	ATXXRA02A-4310-6		
Frequency Range	DC~6.0GHz		
VSWR	1.30 Max		
Power	2 W		
Impedance	50 Ω		
Attenuation	1-10dB	15、20dB	25、30、40dB
Attenuation Tolerance	±0.7dB	±0.8dB	±1.0dB
Connector	4.3-10-J(M)/4.3-10-K(F)		
Dimension	Φ20×68mm		
Operating Temperature	-55 ~ +125°C (See de Power De-rating)		
Weight	About 90 g		
ROHS Compliant	Yes		

### Outline Drawing (Unit: mm/inch):

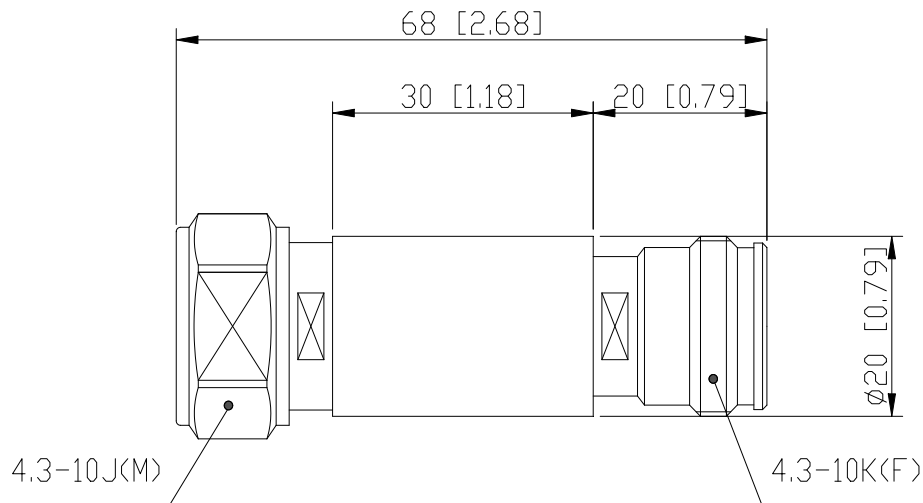
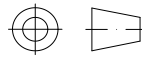

**RFTYT Technology Co., LTD.**

<http://www.rfyt.com>

E-mail: Jackson@rfyt.com      zqc7708@rfyt.com

TEL: +86-13088268828      FAX: +86-816-2846565

218# Wenwu Middle Road, Jinkai District, Mianyang, Sichuan Province China

**Ready For Tackling Your Trouble**



**Naming rules:**

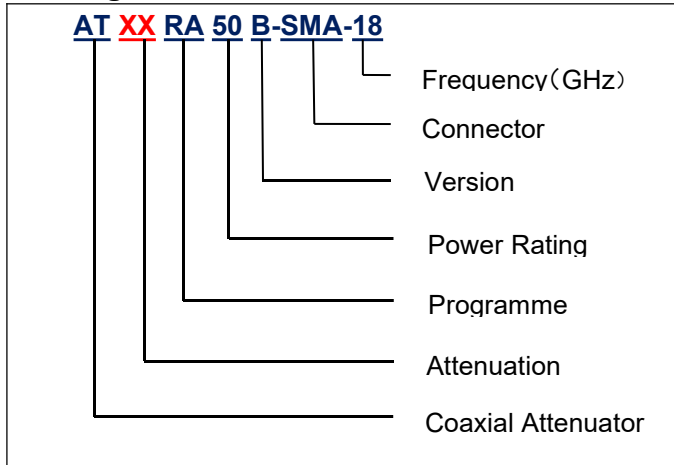

**Power De-rating:**

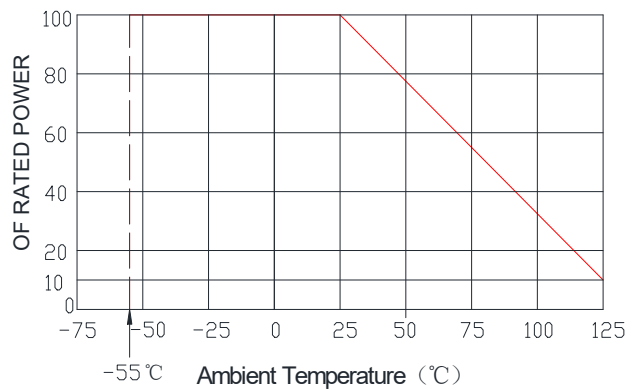

**Graph:**

**3dB**

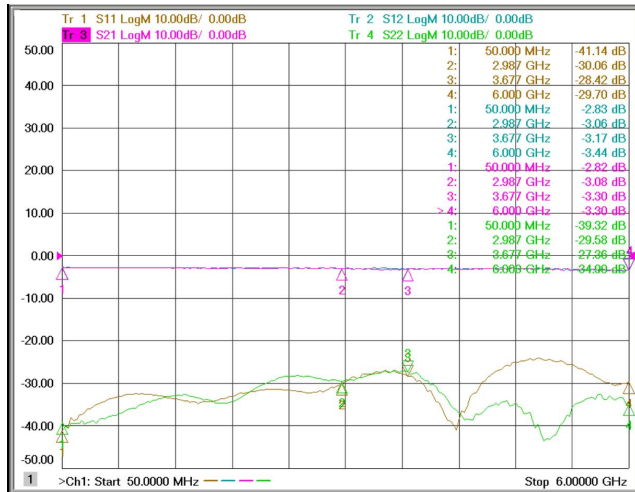

**6dB**

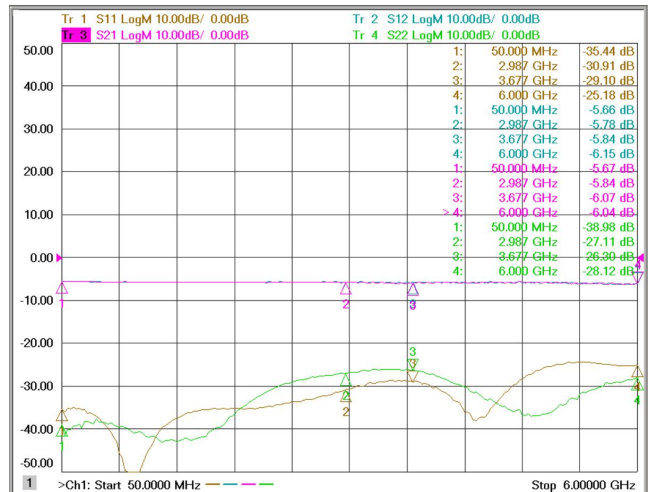

**20dB**

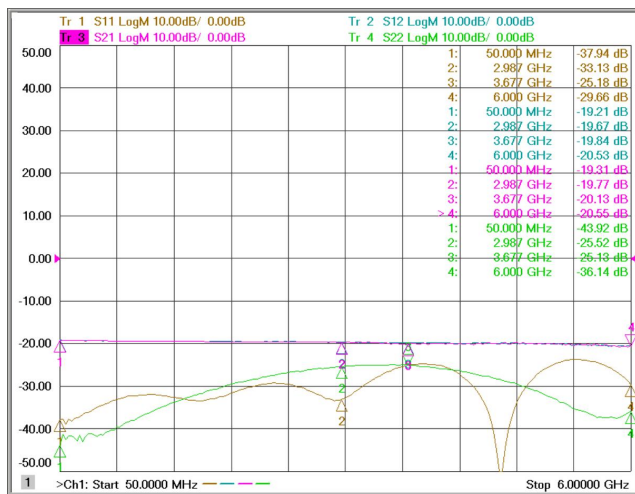

**40dB**

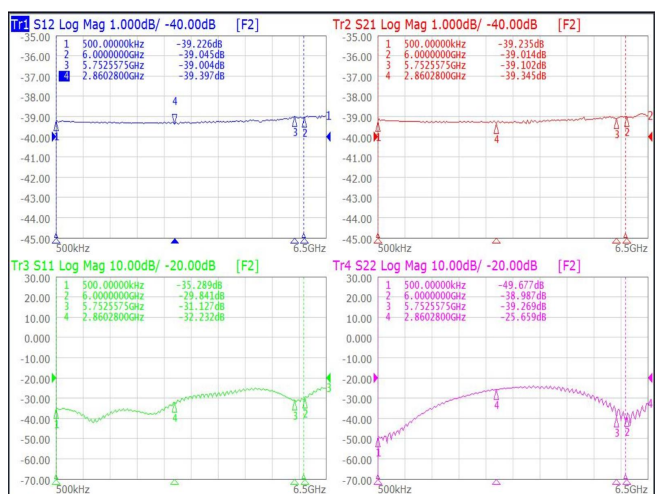



**Use attention:**

- 1、 Dimensions Tolerance  $\pm 3\%$ ;
- 2、 If necessary, the product shall be air-cooled for auxiliary heat dissipation ;
- 3、 Custom designs available of other special attenuators ;
- 4、 Pay attention to the direction of the product during use and strictly prohibit reverse connection。