



Coaxial Fixed Attenuator

Features and Electrical specifications:

Model	RFTXX-05RA3218-1.85-67 (XX=Attenuator Value)		
Frequency Range	DC~67.0GHz		
VSWR	1.40 Max		
Power	5 W		
Impedance	50 Ω		
Attenuation	1-10dB	20dB	30dB
Attenuation Tolerance	-1.0dB/+1.5dB	-1.2dB/+1.5dB	-1.5dB/+2.0dB
Connector	1.85-J(M)/1.85-K(F)		
Dimension	Φ31.8×63.3mm		
Operating Temperature	-55 ~ +125°C (See de Power De-rating)		
Weight	About 30 g		
ROHS Compliant	Yes		

Outline Drawing (Unit: mm/inch):

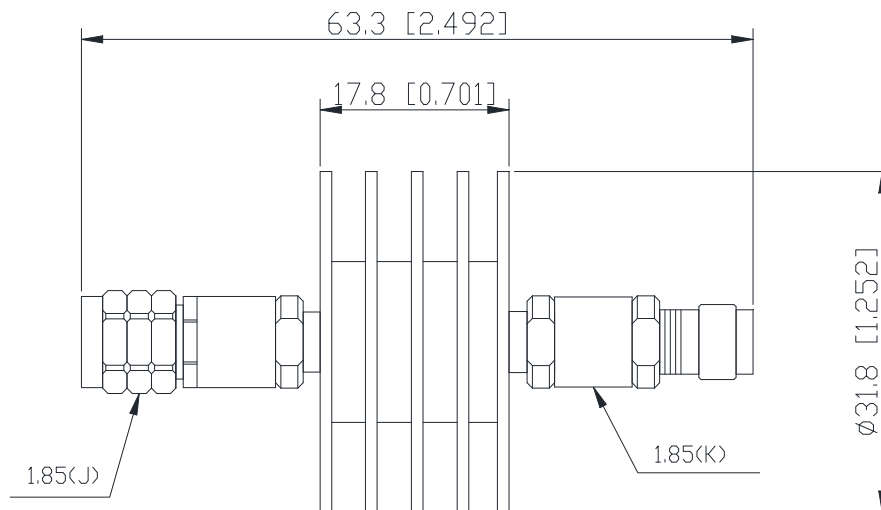



Naming rules:



Power De-rating:



Use attention:

- 1、Dimensions Tolerance $\pm 3\%$;
- 2、If necessary, the product shall be air-cooled for auxiliary heat dissipation;
- 3、Custom designs available of other special coaxial fixed attenuator;
- 4、Pay attention to the direction of the product during use and strictly prohibit reverse connection.