



## Chip Termination

### ◆Features and Electrical specifications:

Model	RFT50N-10CT2550
Frequency Range	DC~6.0GHz
Power	10 W
Resistance Range	50 Ω
Resistance tolerance	±5%
VSWR	1.20 max
Temperature coefficient	<150ppm/°C
Substrate material	AlN
Resistance technology	Thick Film
Operating Temperature	-55 to +155°C (See de Power De-rating)

### ◆Outline Drawing (Unit: mm/inch):

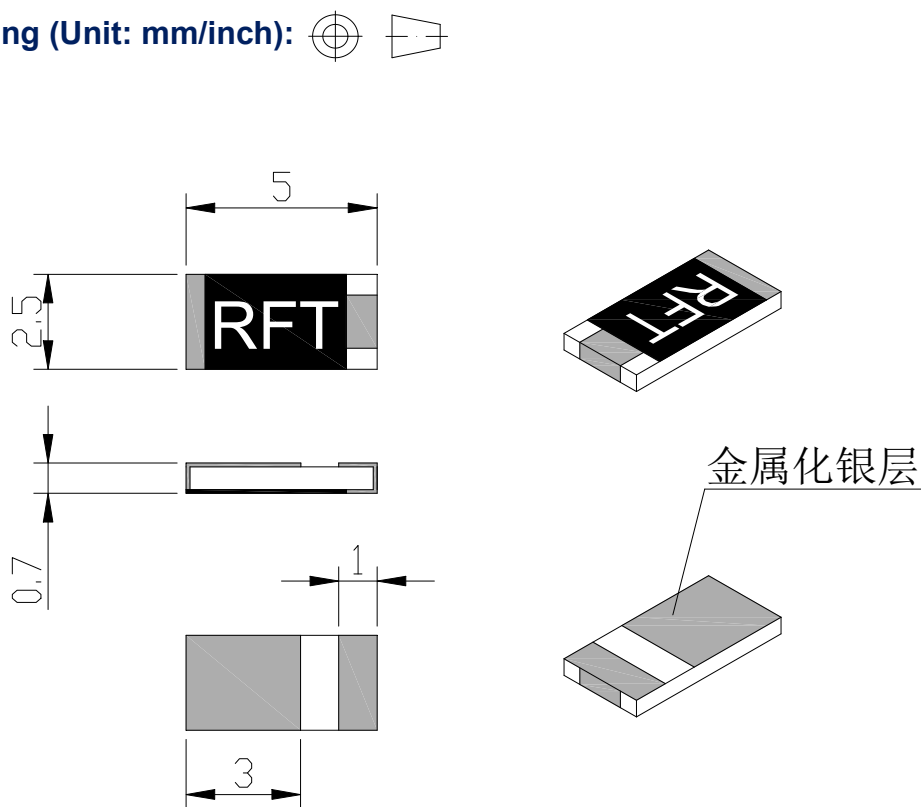

Dimensional tolerance: 5% unless otherwise stated



◆ Typical Performance:

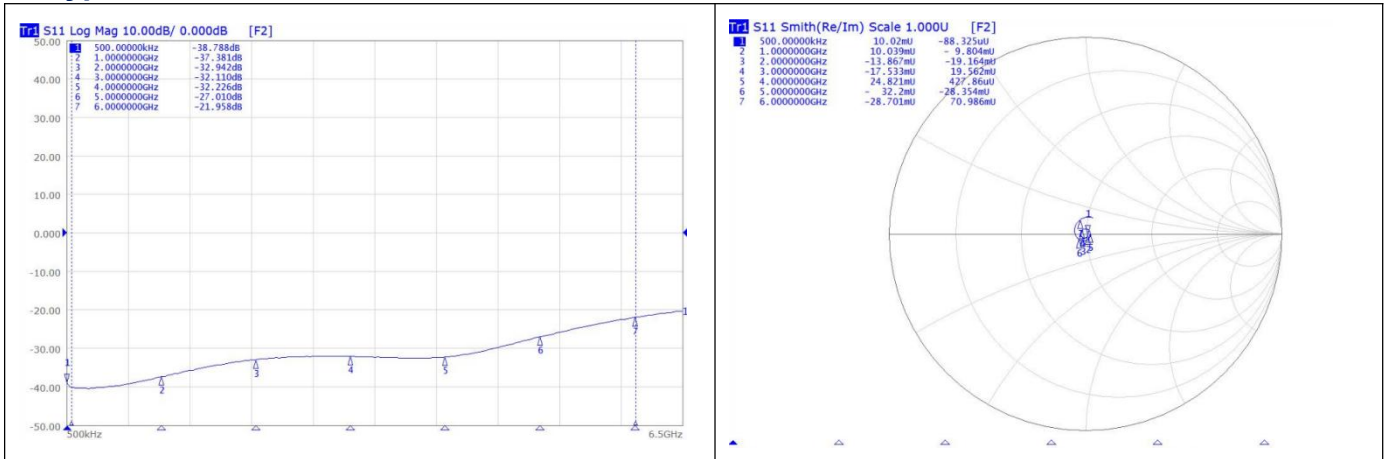

◆ Installation method:

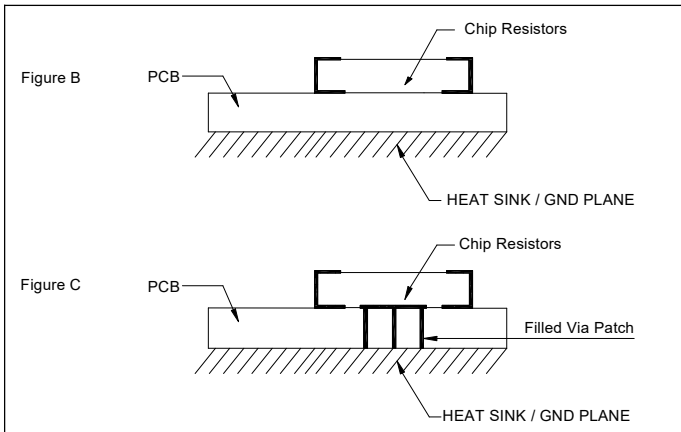

◆ Power De-rating:

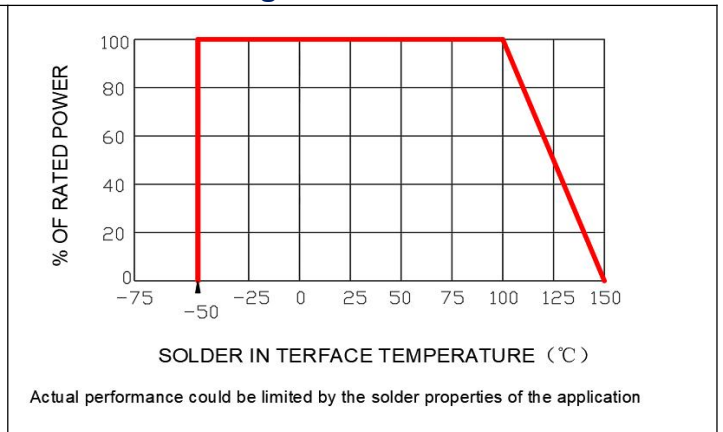

◆ Reflow time and temperature diagram:

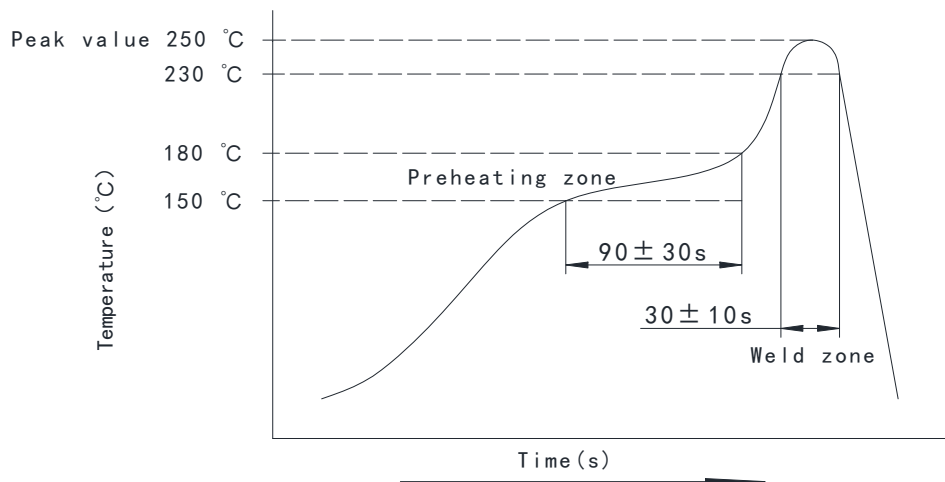



◆P/N Designation:

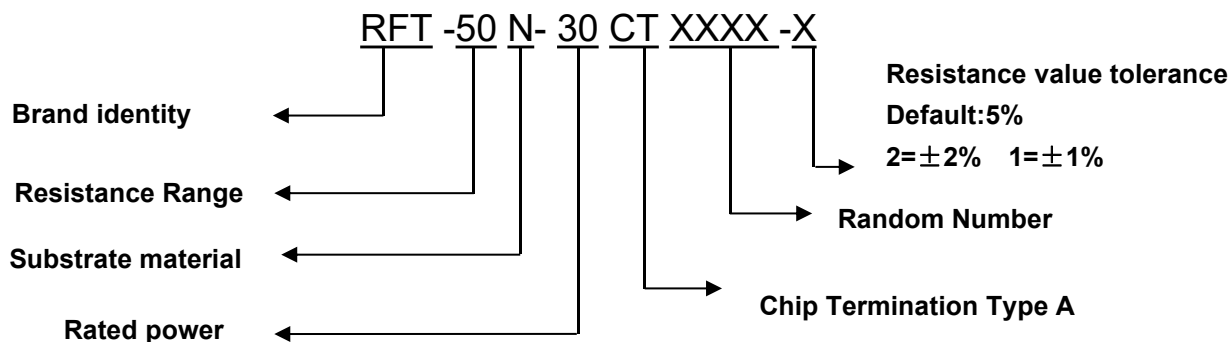

◆Matters needing attention

- After the storage period of newly purchased parts exceeds 6 months, attention should be paid to their weldability before use. It is recommended to store in vacuum packaging.
- Drill out the hot hole on the PCB and fill the solder.
- Reflow welding is preferred for bottom welding, please refer to Reflow introduction
- The manual welding wire should be used under the constant temperature condition of 350 degrees or below, and the welding time should be controlled within 5 seconds.
- In order to meet the requirements of the drawings, a radiator of sufficient size must be installed.
- Add air cooling or water cooling if necessary.
- ◆ Description:
  - Custom designed RF attenuators, RF resistors and RF terminals are available.