



Chip Termination

◆Features and Electrical specifications:

Model	RFT50-10WT5025
Frequency Range	DC~18.0GHz
Power	10 W
Resistance Range	50 Ω
Resistance tolerance	±5%
VSWR	DC~14.0GHz 1.20 Max DC~18.0GHz 1.25 Max
Temperature coefficient	<150ppm/°C
Substrate material	BeO
Cap material	Medium
Resistance technology	Thick Film
Operating Temperature	-55 to +155°C (See de Power De-rating)

◆Outline Drawing (Unit: mm/inch):

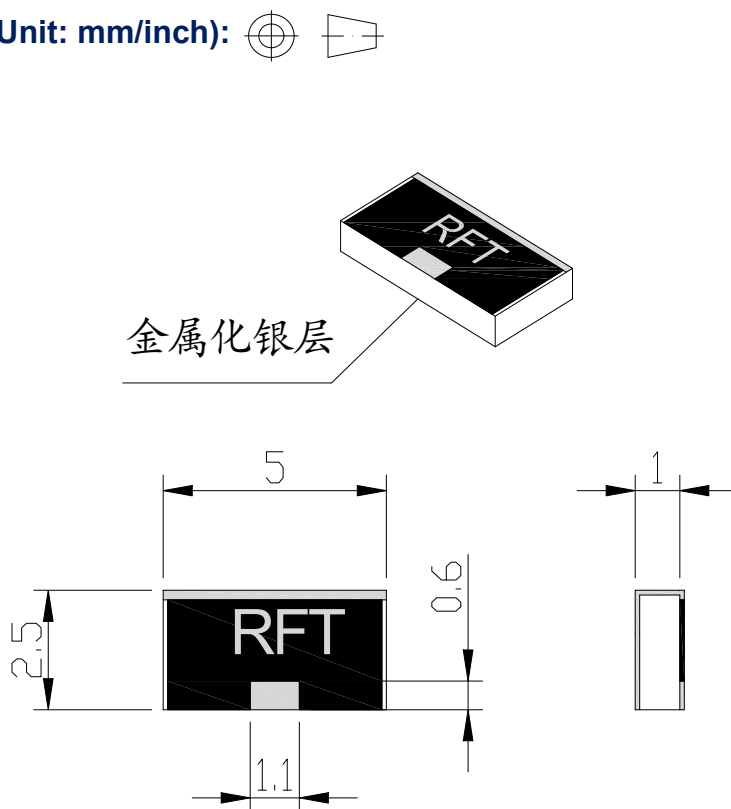

Dimensional tolerance: 5% unless otherwise stated

RFTYT Technology Co., LTD.

<http://www.rfyt.com>

E-mail: Jackson@rfyt.com

Cerman.wu@rfyt.com

TEL: +86-13088268828

FAX: +86-816-2846565

218# Wenwu Middle Road, Jinkai District, Mianyang, Sichuan Province China

Ready For Tackling Your Trouble



◆Typical Performance:

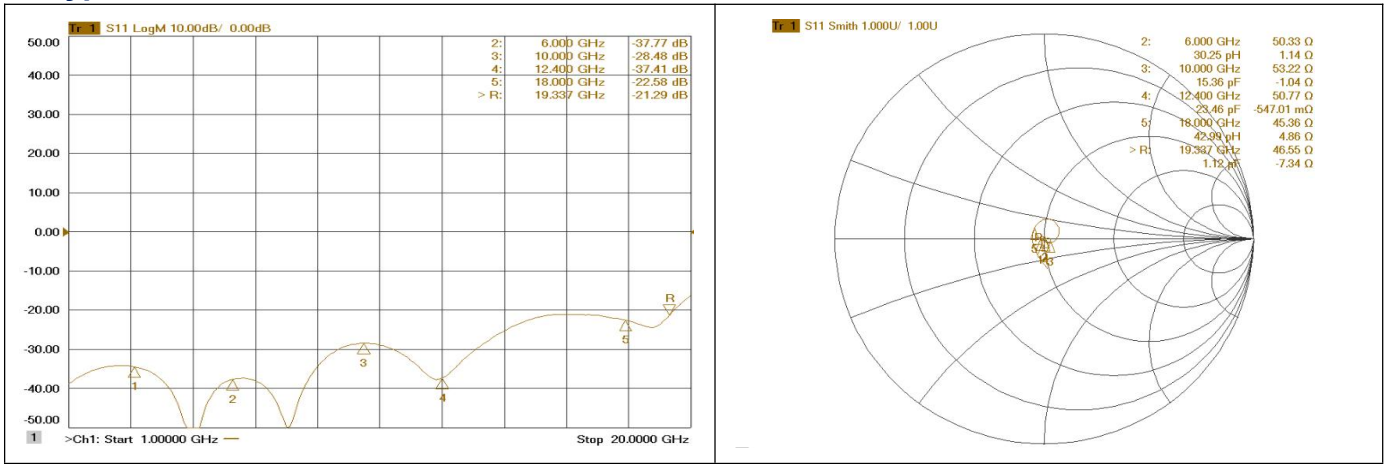

◆Installation method:

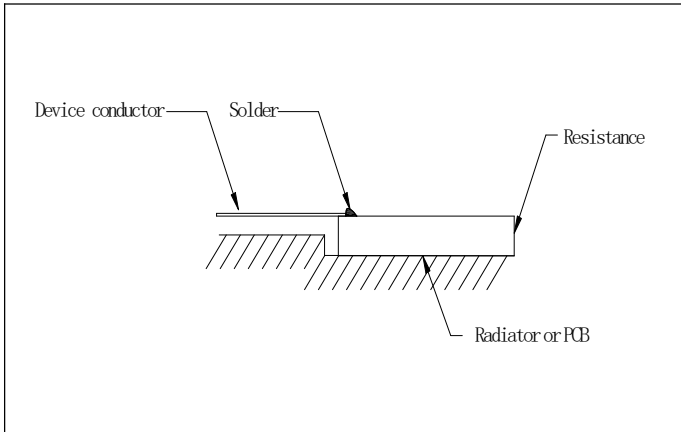

◆Power De-rating:

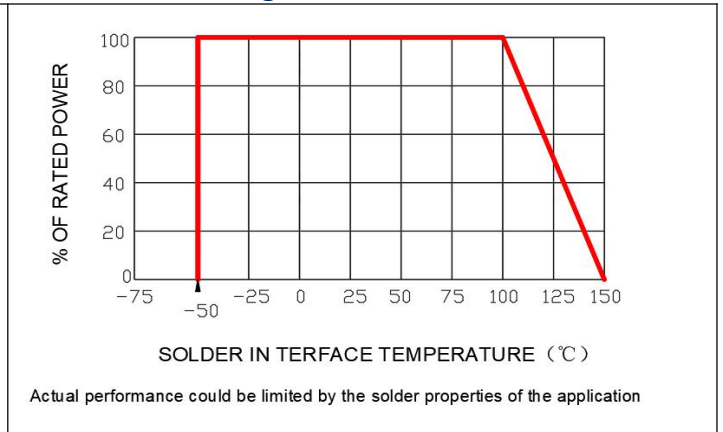

◆Reflow time and temperature diagram:

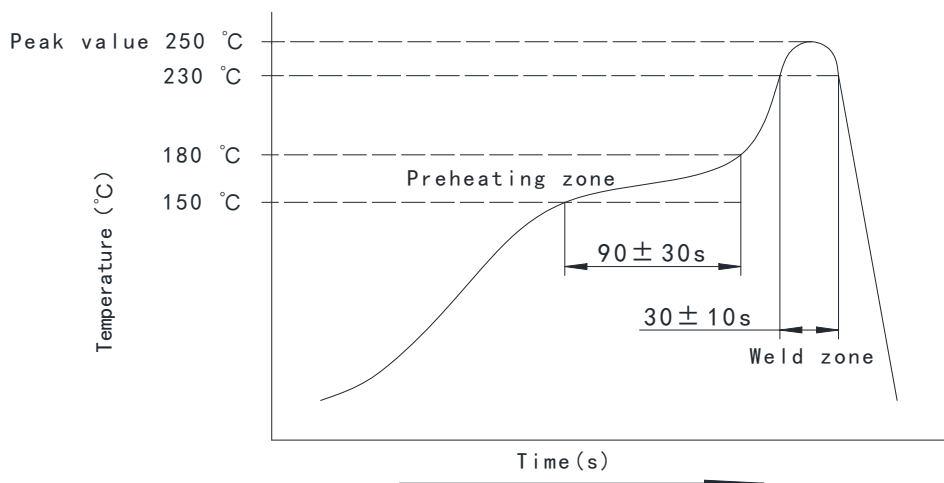



◆P/N Designation:

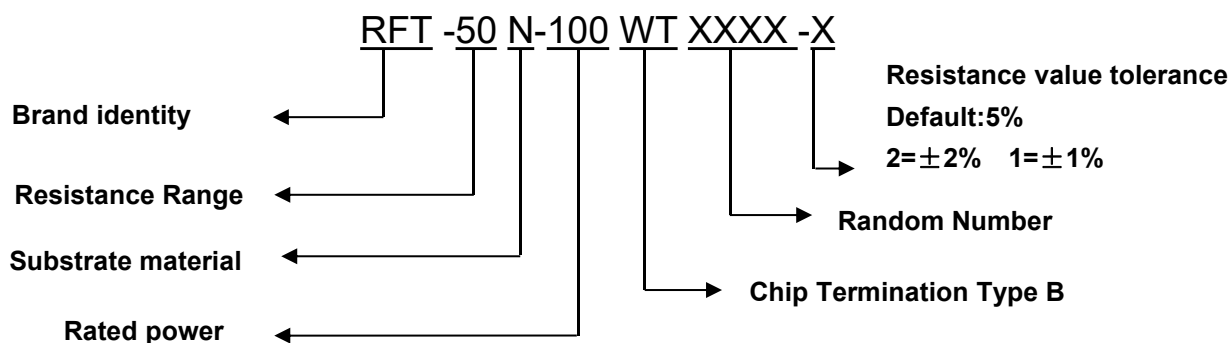

◆Matters needing attention

- After the storage period of newly purchased parts exceeds 6 months, attention should be paid to their weldability before use. It is recommended to store in vacuum packaging.
- Drill out the hot hole on the PCB and fill the solder.
- Reflow welding is preferred for bottom welding, please refer to Reflow introduction
- The manual welding wire should be used under the constant temperature condition of 350 degrees or below, and the welding time should be controlled within 5 seconds.
- In order to meet the requirements of the drawings, a radiator of sufficient size must be installed.
- Add air cooling or water cooling if necessary.
- ◆ Description:
 - Custom designed RF attenuators, RF resistors and RF terminals are available.