

1.25 to 3.0GHz Coaxial Isolator

TG5050AS SMA Type

Outline Drawing (mm):

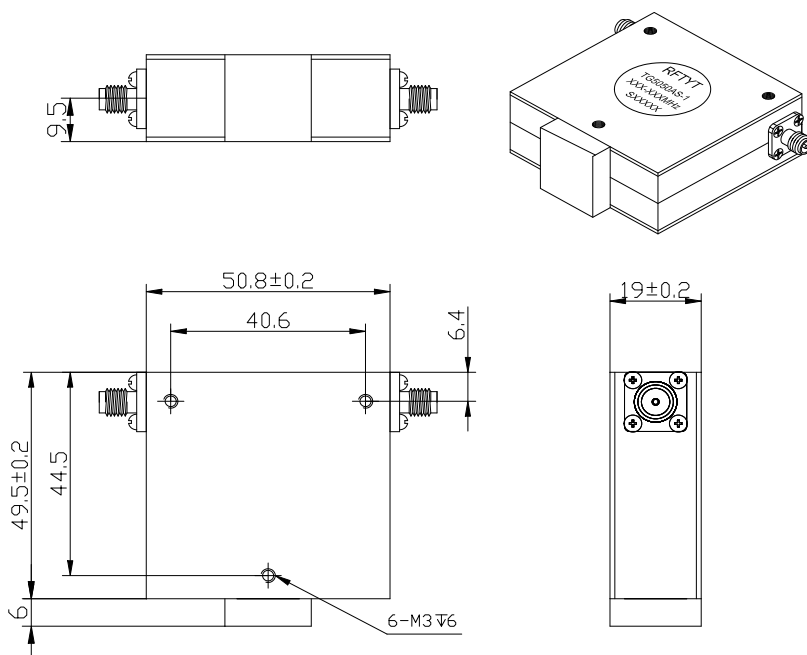

Features:

- ◇ Good temperature stability
- ◇ Withstand high power
- ◇ RoHS compliant
- ◇ Weight : ≈ 356 g

Material list:

- ◇ Cavity: aluminum conductive oxidation
- ◇ Outer shell: industrial pure iron nickel plating
- ◇ Inner conductor: silver plated brass
- ◇ Load chamber: aluminum conductive oxidation

Application:

- ◇ Rf amplifier final stage, protect the amplifier
- ◇ Medium capacity microwave communication
- ◇ GSM/CDMA/TD-SCDMA/WCDMA
- ◇ EGSM/Wimax/TD-LTE/AMPS/SMR

Order Examples:

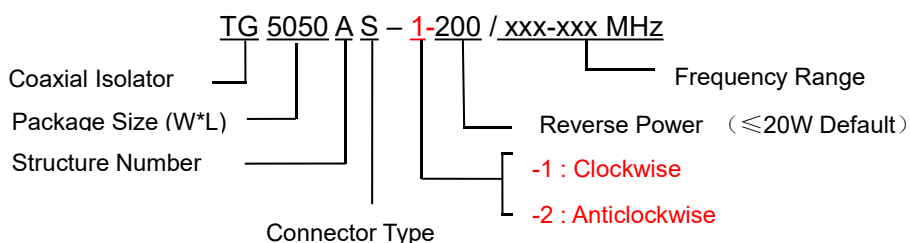

Connector Type:

SMA Type Connector Options			N Type Connector Options		
Port 1	Port 2	Abbreviation	Port 1	Port 2	Abbreviation
SMA-F	SMA-F	S	N-F	N-F	N
SMA-F	SMA-M	SKJ	N-F	N-M	NKJ
SMA-M	SMA-F	SJK	N-M	N-F	NJK
SMA-M	SMA-M	SJ	N-M	N-M	NJ

Basic Specifications :

Impedance	50 Ω
Connector Type	SMA-F
Size(mm)	49.5*50.8*19.0
Operating Temp	-10~+60℃
Storage temperature	-50~+90℃

Specifications :

Model No. (X=1: →Clockwise) (X=2: ←Anticlockwise)	Freq. Range GHz	IL. dB (max)	Isolation dB (min)	VSWR	Forward Power CW	Reverse Power W
TG5050AS-X/1250-2500MHz	1.25-2.5	0.80	16.0	1.50	100	20
TG5050AS-X/1350-2700MHz	1.35-2.7	0.60	17.0	1.35	100	20
TG5050AS-X/1350-2900MHz	1.35-2.9	0.70	16.0	1.50	100	20
TG5050AS-X/1400-2800MHz	1.4-2.8	0.60	17.0	1.35	100	20
TG5050AS-X/1500-2500MHz	1.5-2.5	0.50	18.0	1.30	100	20
TG5050AS-X/1500-3000MHz	1.5-3.0	0.60	17.0	1.35	100	20

Instructions:

- 1, the isolator connector can be selected SMA, N, male and female head can be used with the user;
- 2, the reflection power is commonly used 20W and 100W options, you can also configure the total reflection power according to user requirements;
- 3, only some common frequencies in the table, can be produced according to the user's requirements;
- 4, if you do not find what you are looking for, please contact us!