



Directional Coupler

Features and Electrical specifications:

Model	CP10-F1528-G/6-40GHz
Frequency Range	6~40GHz
Insertion Loss	1.2dB (Excluding 0.45dB coupling loss)
Nominal Coupling	10±1dB
Coupling Sensitivity	±1.0dB
Directivity	≥10dB
VSWR	1.60 Max
Rated Power	20W
Impedance	50 Ω
Connector Type	2.92-F
Dimension	28x15x11 mm
Surface Finishing	Grey Painting
Operating Temperature	-55 ~ +85°C
ROHS Compliant	Yes

Outline Drawing (Unit: mm):

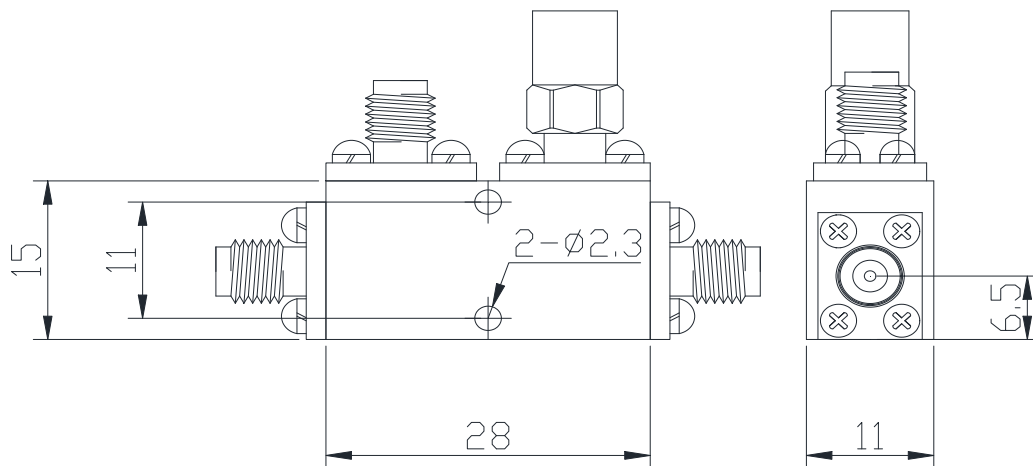
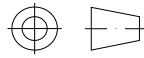

RFTYT Technology Co., LTD.

<http://www.rftyt.com>

E-mail : jackson@rftyt.com zqc7708@rftyt.com

TEL: +86-13088268828 FAX: +86-816-2846565

218# Wenwu Middle Road, Jinkai District, Mianyang, Sichuan Province China

Ready For Tackling Your Trouble