



Coaxial Fixed Attenuator

Features and Electrical specifications:

Model	RFTXX-10RA3218-2.4-50 (XX=Attenuator Value)		
Frequency Range	DC~50.0GHz		
VSWR	1.35 Max		
Power	10 W		
Impedance	50 Ω		
Attenuation	1-10dB	20dB	30dB
Attenuation Tolerance	-1.0dB /+1.2dB	-1.0dB /+1.2dB	-1.2dB /+1.5dB
Connector	2.4-J(M)/2.4-K(F)		
Dimension	Φ31.8×63.3mm		
Operating Temperature	-55 ~ +125°C (See de Power De-rating)		
Weight	About 30 g		
ROHS Compliant	Yes		

Outline Drawing (Unit: mm/inch):

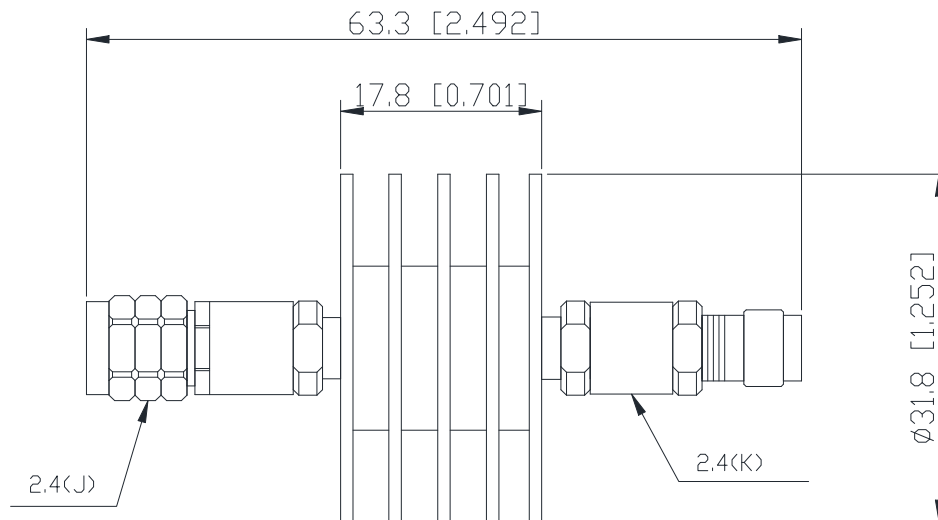

RFTYT Technology Co., LTD.

<http://www.rfyt.com>

E-mail: Jackson@rfyt.com zqc7708@rfyt.com

TEL: +86-13088268828 FAX: +86-816-2846565

218# Wenwu Middle Road, Jinkai District, Mianyang, Sichuan Province China

Ready For Tackling Your Trouble



Naming rules:



Power De-rating:



Use attention:

- 1、Dimensions Tolerance $\pm 3\%$;
- 2、If necessary, the product shall be air-cooled for auxiliary heat dissipation;
- 3、Custom designs available of other special coaxial fixed attenuator;
- 4、Pay attention to the direction of the product during use and strictly prohibit reverse connection.