



## Coaxial Fixed Attenuator

### Features and Electrical specifications:

Model	RFTXX-100RA6016-N-12.4 (XX=Attenuator Value)
Frequency Range	DC~12.4GHz
VSWR	1.45Max
Power	100 W
Impedance	50 Ω
Attenuation	10、20、30、40、50dB
Attenuation Tolerance	-1.5dB/+2.5dB
Connector	N-J(M)/N-K(F)
Dimension	Φ60.0*198.9 mm
Operating Temperature	-55 ~ +125°C (See de Power De-rating)
Weight	About 600 g
ROHS Compliant	Yes

### Outline Drawing (Unit: mm/inch):

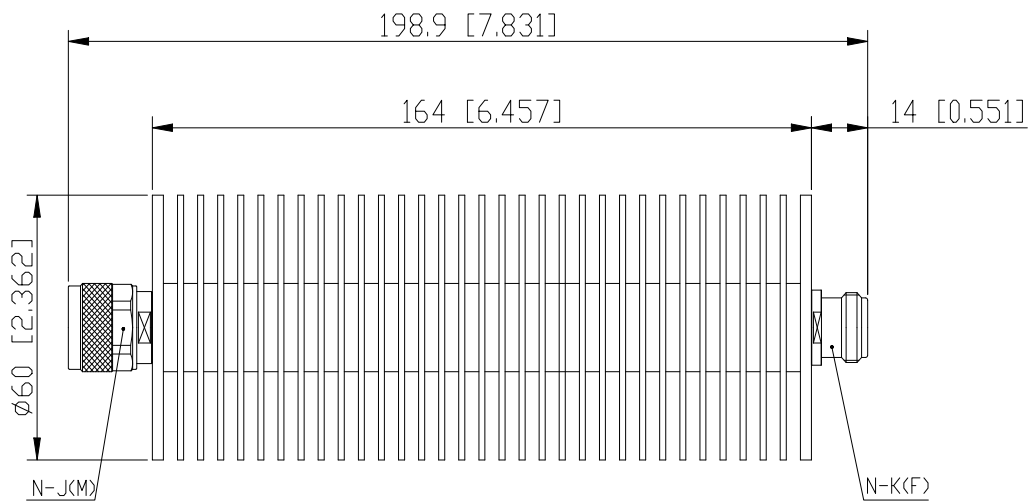

The connector could be SMA, N MM or FF  
or any two can be freely mixed and matched



**Naming rules:**

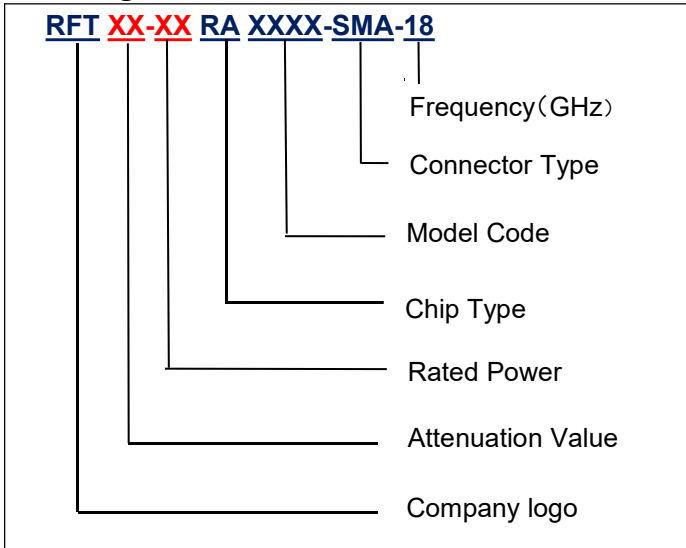

**Power De-rating:**

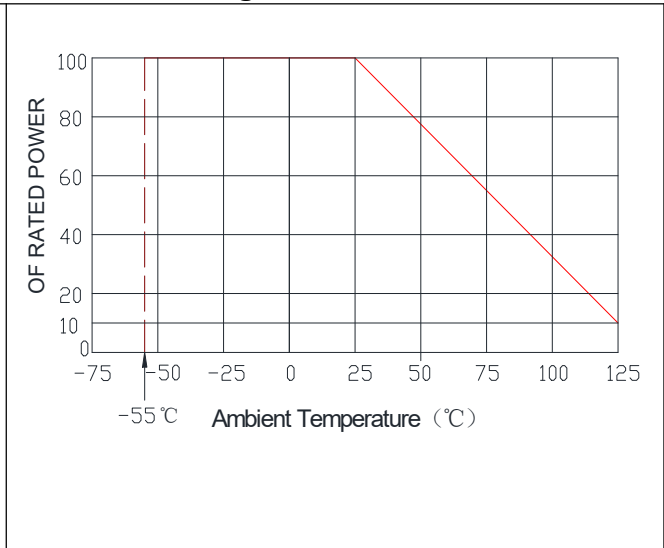

**Graph:**

**20dB**

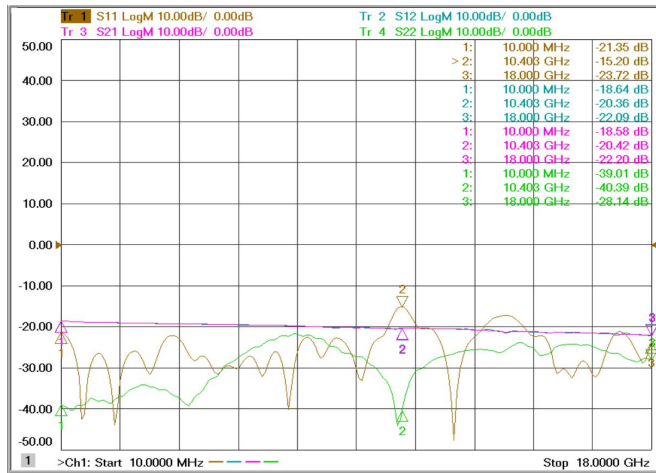

**30dB**

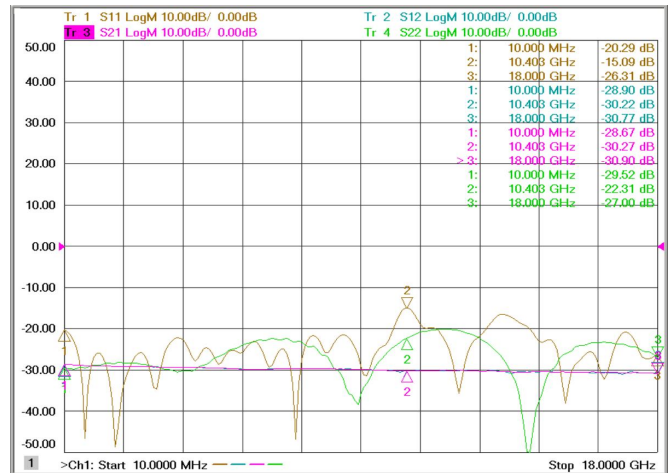

**40dB**

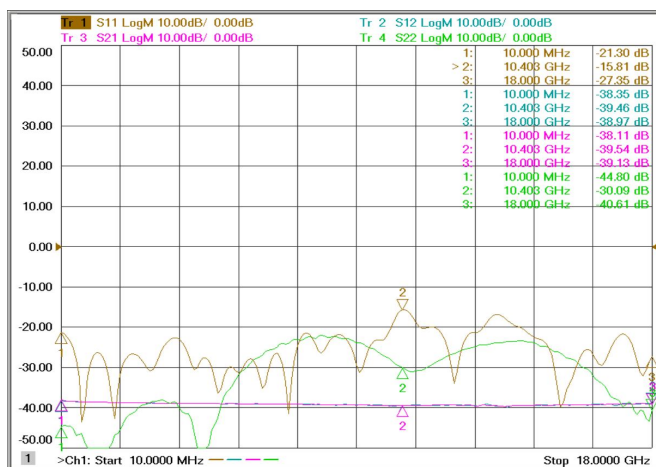

**50dB**

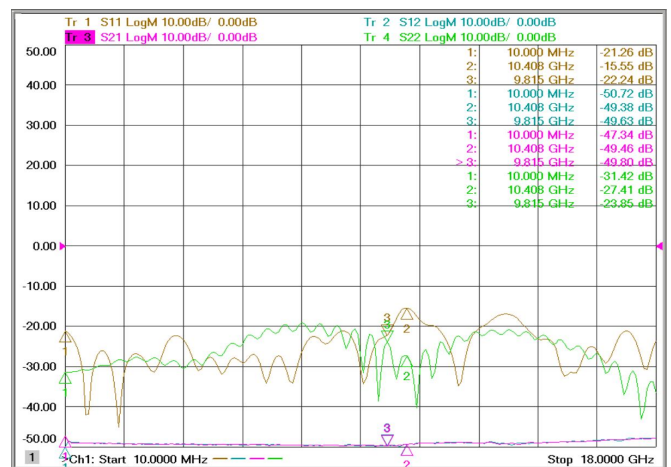



**Use attention:**

- 1、 Dimensions Tolerance  $\pm 3\%$ ;
- 2、 If necessary, the product shall be air-cooled for auxiliary heat dissipation ;
- 3、 Custom designs available of other special coaxial fixed attenuator ;
- 4、 Pay attention to the direction of the product during use and strictly prohibit reverse connection.