



## Microstrip Attenuator With Sleeve

### ◆Features and Electrical specifications:

Model	RFTXX-05TA7265-18 (XX=Attenuation value)		
Resistance Range	50 Ω		
Frequency Range	DC~18.0 GHz		
Power	5 W		
Attenuation(dB)	01-10	11-20	21-30
Attenuation Tolerance(dB)	±0.7	±0.8	±1.0
VSWR	1.25 type 1.3 max		
Temperature Coefficient	<150ppm/°C		
Substrate material	BeO		
Sleeve Material	Al (Conductive oxidation)		
Resistance Process	Thick Film		
Operating Temperature	-55 to +125°C (See de Power De-rating)		
ROHS Compliant	Yes		

### ◆Outline Drawing (Unit: mm/inch):

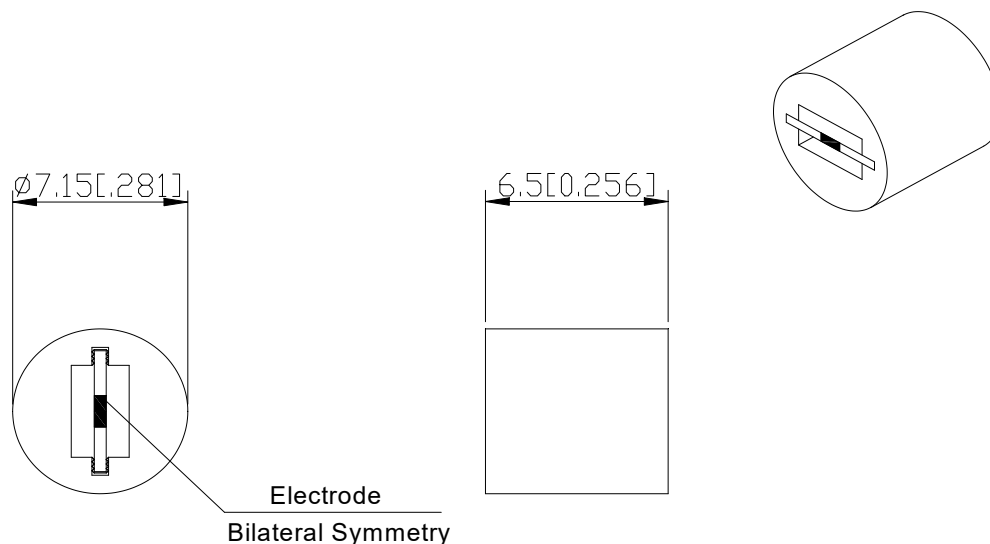

**Diameter tolerance:  $\pm 0.05$ , length tolerance:  $\pm 0.05$**

**RFTYT Technology Co., LTD.**

<http://www.rftyt.com>

E-mail: [jackson@rftyt.com](mailto:jackson@rftyt.com)

[cerman@rftyt.com](mailto:cerman@rftyt.com)

TEL: +86-13088268828

FAX: +86-816-2846565

218# Wenwu Middle Road, Jinkai District, Mianyang, Sichuan Province China

**Ready For Tackling Your Trouble**



◆ Typical Performance:

3dB Graph

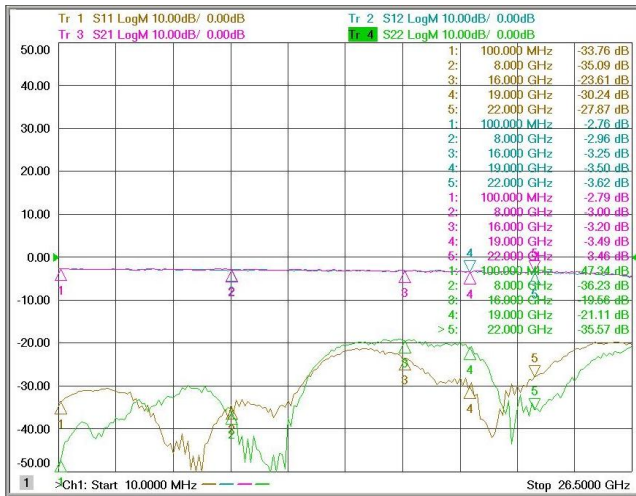

5dB Graph

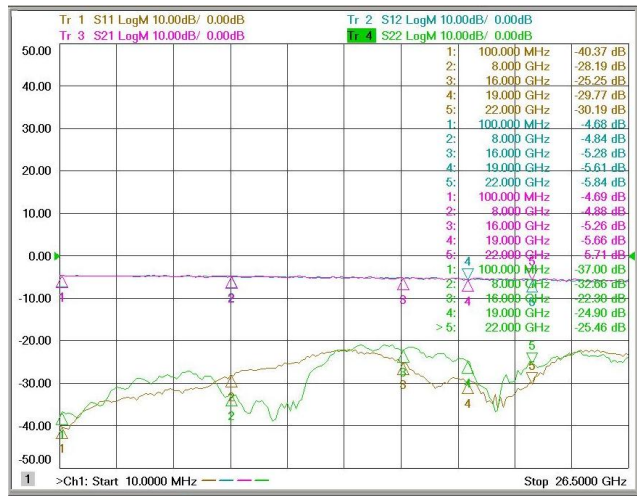

6dB Graph

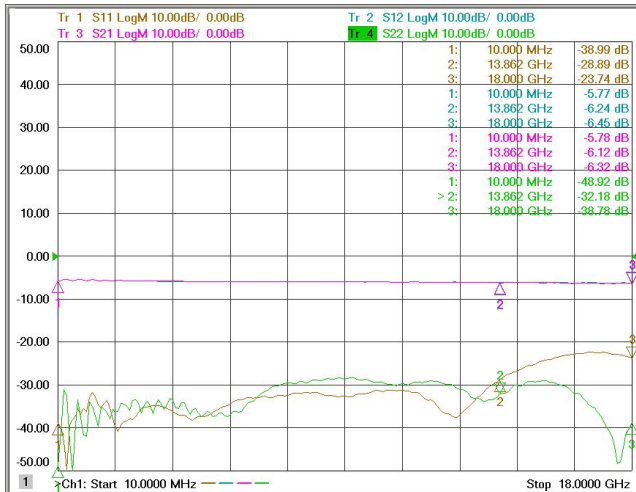

10dB Graph

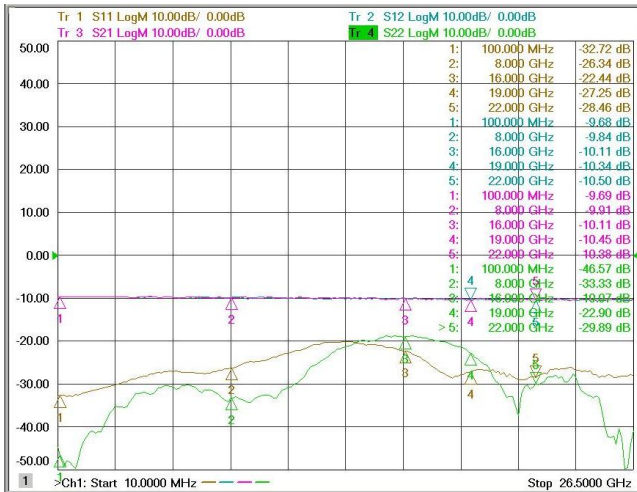

20dB Graph

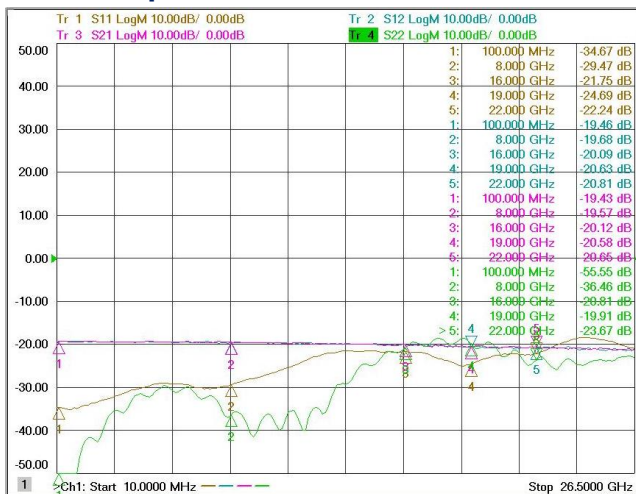

30dB Graph

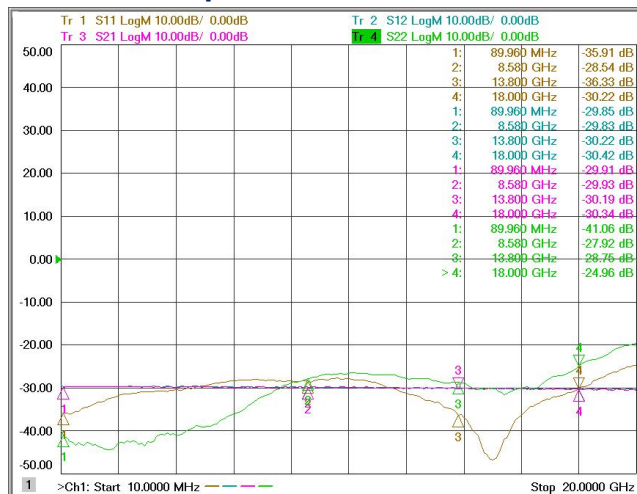



◆Use Attention:

1. Elastic contact is used at the contact point between the connector and the sleeve electrode;
  2. The inner hole of the radiator should match the diameter of the sleeve, and the tolerance should not be too large;
- Operation steps:
- A. Tighten one end of the connector with a thread to one end of the radiator;
  - B. Place the sleeve type attenuation plate into the internal hole of the radiator;
  - C. Then tighten the connector on the other end with a thread
  - D. Attention: Thread requires the use of thread sealant

◆Power De-rating:

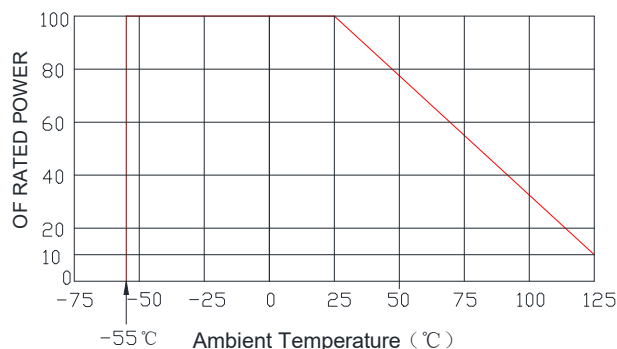

◆P/N Designation:

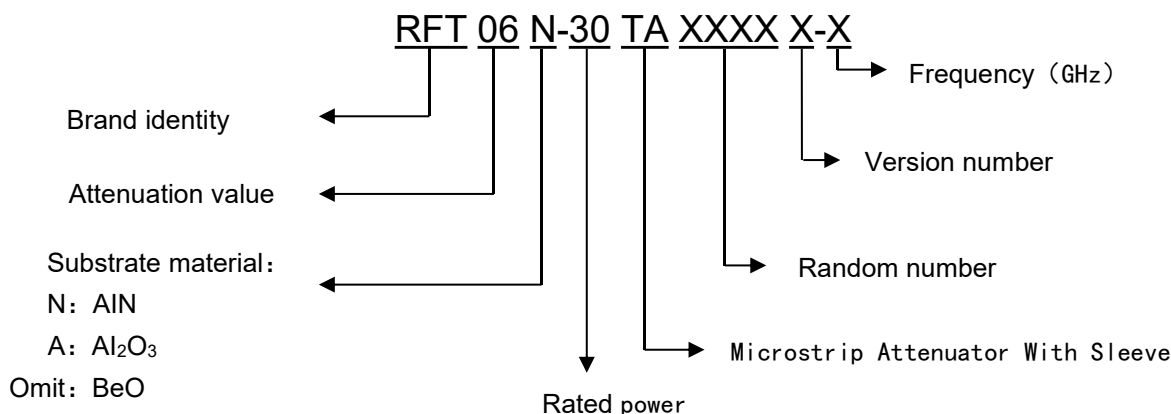

◆Notes:

- The sleeve and radiator need to be tightly connected to ensure heat dissipation.
- Good grounding is required to ensure S parameters.
- In order to meet the requirements of the drawings, it is necessary to install radiators of sufficient size.
- If necessary, increase air cooling or water cooling.
- The connection between the connector and the sleeve type attenuation electrode must use elastic contact.
- If the sleeve is marked with "IN", be sure to place one end of the IN on the input port, and if there is no label, it will be bidirectional.

◆Remarks:

- We can provide customized RF attenuators, RF resistors, coaxial dummy (termination) loads, and mismatched dummy (termination) loads.