



Coaxial Fixed Attenuator

Features and Electrical specifications:

Model	RFTXX-20RA3657-SMA-6 (XX=Attenuator Value)			
Frequency Range	DC~6.0GHz			
VSWR	1.20 Max			
Power	20 W			
Impedance	50 Ω			
Attenuation	01-10dB	11-20dB	25、30dB	40、50、60dB
Attenuation Tolerance	±0.6dB	±0.8dB	±1.0dB	±1.1dB
Connector	SMA-J(M)/ SMA-K(F)			
Dimension	Φ36×88.2mm			
Operating Temperature	-55 ~ +125°C (See de Power De-rating)			
Weight	About 120 g			
ROHS Compliant	Yes			

Outline Drawing (Unit: mm/inch):

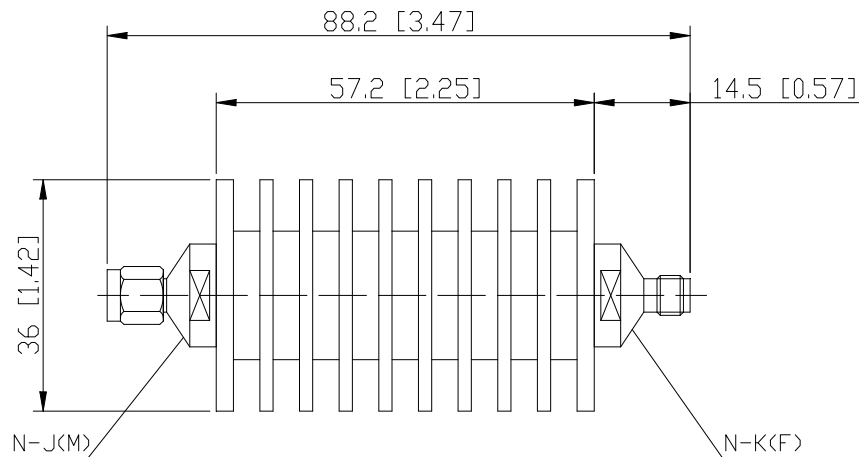
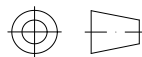

The connector could be SMA, DIN, 4.3-10 MM or FF ,
or any two can be freely mixed and matched

RFTYT Technology Co., LTD.

<http://www.rfyt.com>

E-mail: Jackson@rfyt.com zqc7708@rfyt.com

TEL: +86-13088268828 FAX: +86-816-2846565

218# Wenwu Middle Road, Jinkai District, Mianyang, Sichuan Province China

Ready For Tackling Your Trouble



Naming rules:

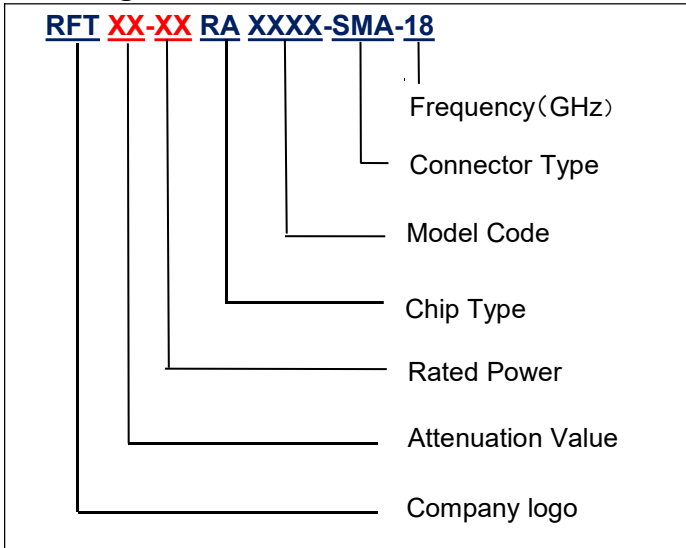

Power De-rating:

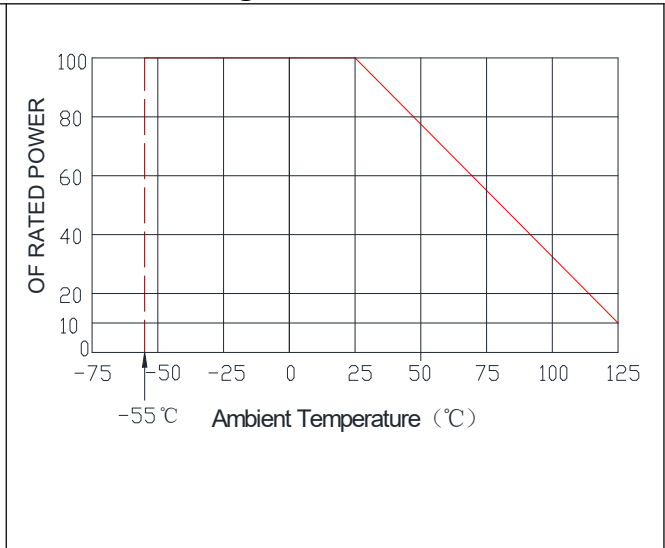

Graph:

3dB

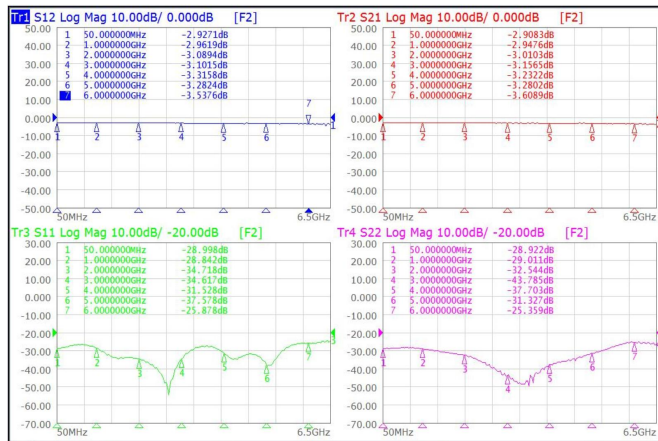

10dB

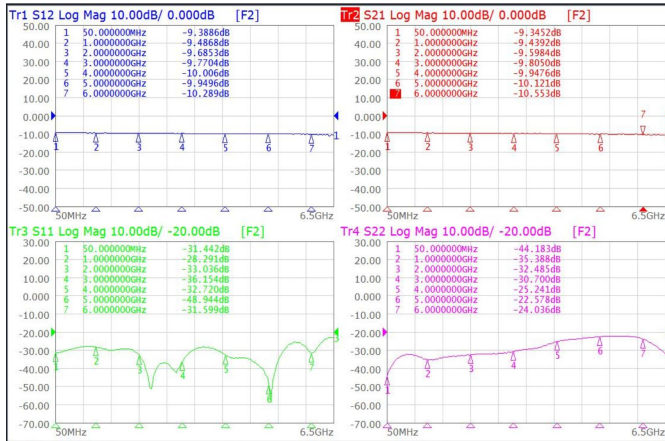

20dB

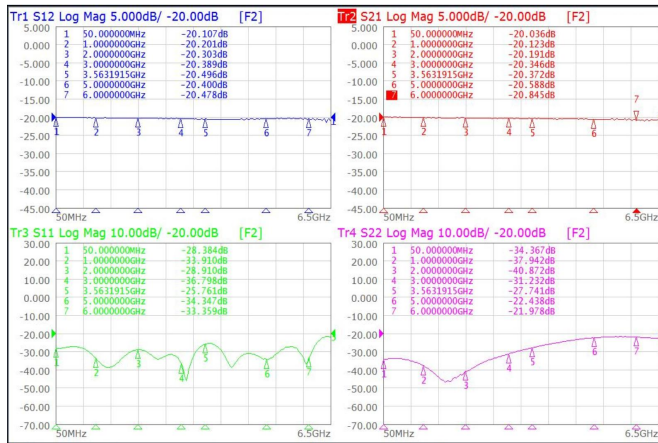

30dB

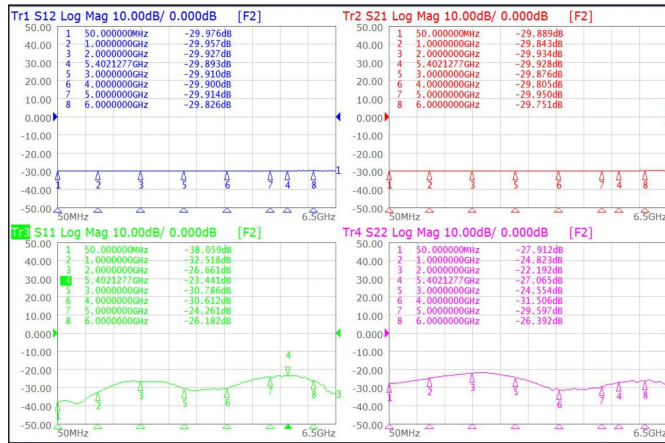



40dB

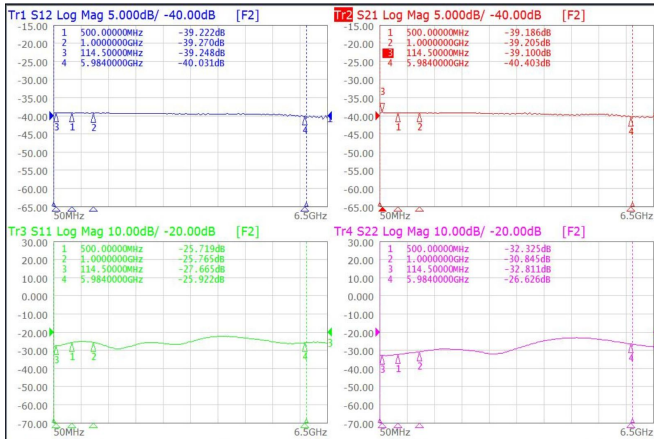

60dB

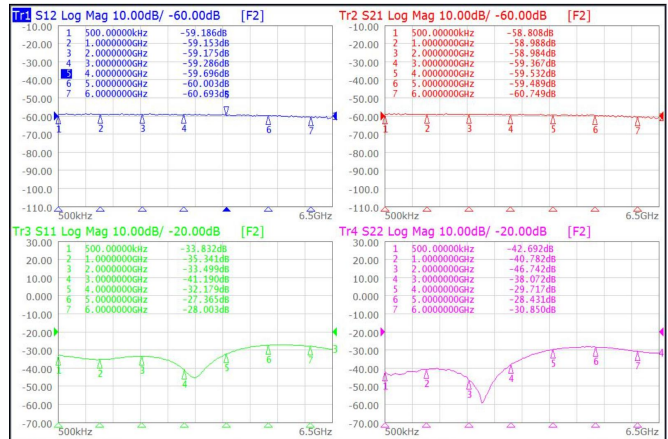

Use attention:

- 1、Dimensions Tolerance $\pm 3\%$;
- 2、If necessary, the product shall be air-cooled for auxiliary heat dissipation ;
- 3、Custom designs available of other special coaxial fixed attenuator ;
- 4、Pay attention to the direction of the product during use and strictly prohibit reverse connection.