



Band Stop Filter

Features and Electrical specifications:

Model	BSF-1710M1780A-S
Rejection band	1710-1780MHz
Pass band	DC~1695MHz & 1795~3000MHz
Insertion Loss	≤2.0dB
Rejection	≥40dB
VSWR	2.0 Max
Rated Power	10 W
Impedance	50 Ω
Connector Type	SMA-F
Dimension	157.0x40.0x22.0mm
Surface Finishing	Black Painting
Operating Temperature	Ordinary temperature
Storage Temperature	-55 ~ +85°C

Outline Drawing (Unit: mm):

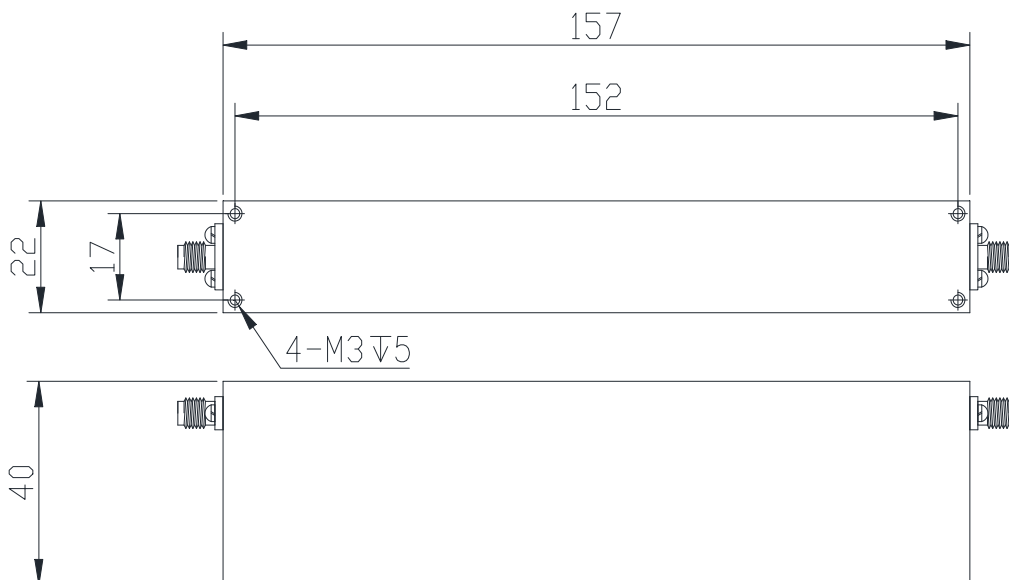

RFTYT Technology Co., LTD.

<http://www.rftyt.com>

E-mail : jackson@rftyt.com zqc7708@rftyt.com

TEL: +86-13088268828 FAX: +86-816-2846565

218# Wenwu Middle Road, Jinkai District, Mianyang, Sichuan Province China

Ready For Tackling Your Trouble