



## 3 Way Power Divider

### Features and Electrical specifications:

Model	PD03-F1271-N/300-500MHz
Frequency Range	300-500 MHz
Insertion Loss	≤0.6dB
Split loss	4.8dB
Isolation	≥20 dB
VSWR	1.35Max
Rated Power	50 W
Impedance	50 Ω
Connector Type	N-F
Waterproof Grade	IP65
Relative Humidity	≤95%
Surface Finishing	Black Painting
Operating Temperature	-20 ~ +60°C
ROHS Compliant	Yes

Outline Drawing (Unit: mm):

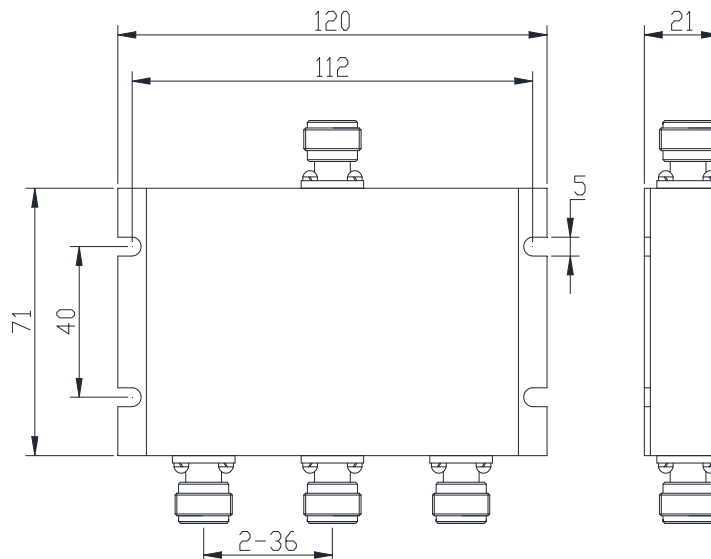
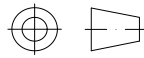

**RFTYT Technology Co., LTD.**

<http://www.rftyt.com>

E-mail : [jackson@rftyt.com](mailto:jackson@rftyt.com)      [zqc7708@rftyt.com](mailto:zqc7708@rftyt.com)

TEL: +86-13088268828      FAX: +86-816-2846565

218# Wenwu Middle Road, Jinkai District, Mianyang, Sichuan Province China

**Ready For Tackling Your Trouble**