



Microstrip Attenuator With Sleeve

◆Features and Electrical specifications:

Model	RFTXXN-10TA1413-6 (XX=Attenuation value)			
Resistance Range	50 Ω			
Frequency Range	DC~6.0 GHz			
Power	10 W			
Attenuation(dB)	01-10	11-20	21-30	40
Attenuation Tolerance(dB)	±0.5	±0.6	±1.0	±1.0
VSWR	1.20 type 1.25 max			
Temperature Coefficient	<150ppm/°C			
Substrate material	AlN			
Sleeve Material	Al (Conductive oxidation)			
Resistance Process	Thick Film			
Operating Temperature	-55 to +125°C (See de Power De-rating)			
ROHS Compliant	Yes			

◆Outline Drawing (Unit: mm/inch):

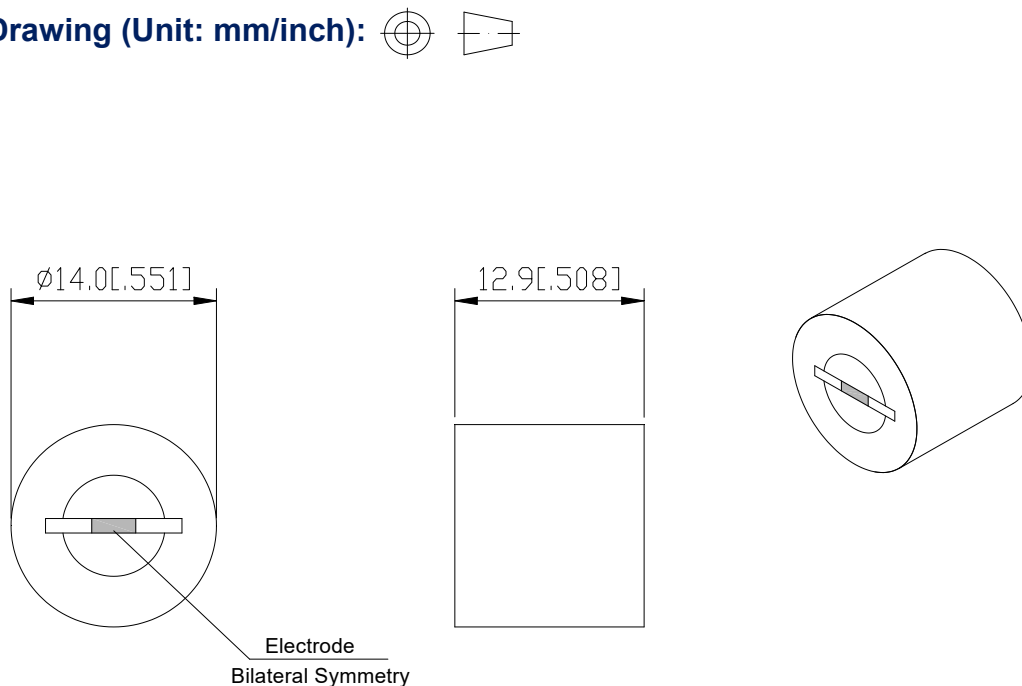

Diameter tolerance: ±0.05, length tolerance: ± 0.05

RFTYT Technology Co., LTD.

<http://www.rftyt.com>

E-mail: jackson@rftyt.com

cerman@rftyt.com

TEL: +86-13088268828

FAX: +86-816-2846565

218# Wenwu Middle Road, Jinkai District, Mianyang, Sichuan Province China

Ready For Tackling Your Trouble



◆ Typical Performance:

1dB Graph

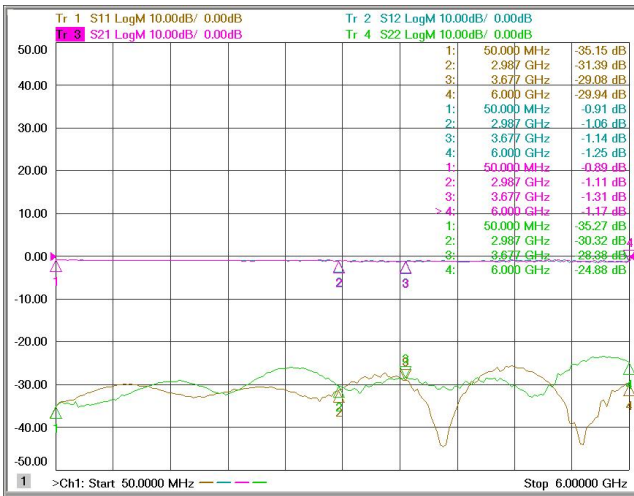

2dB Graph

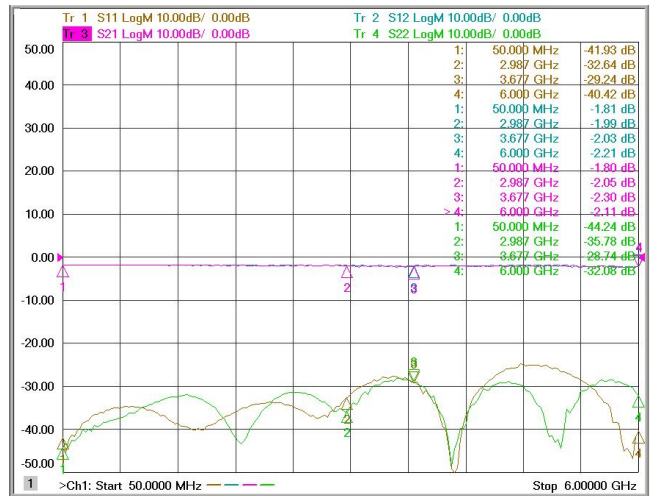

3dB Graph



4dB Graph

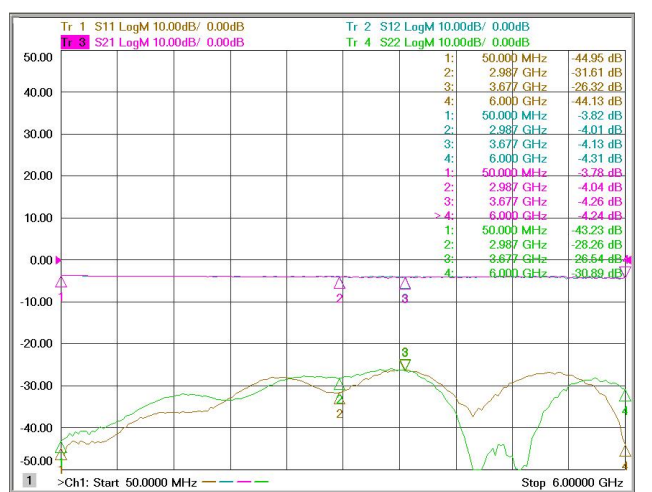

5dB Graph

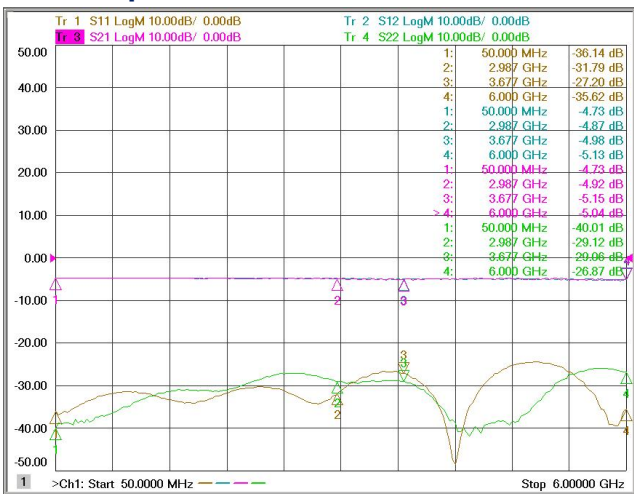

6dB Graph

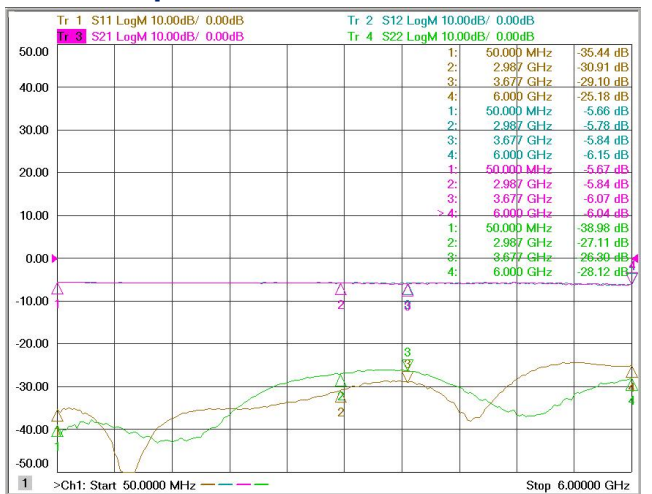



7dB Graph

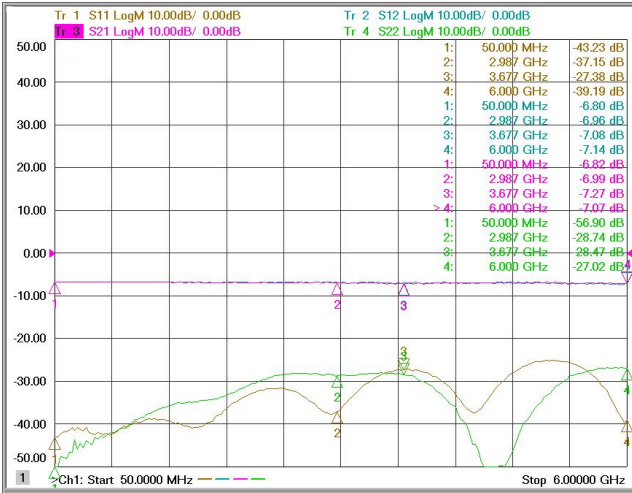

8dB Graph



9dB Graph



10dB Graph



20dB Graph

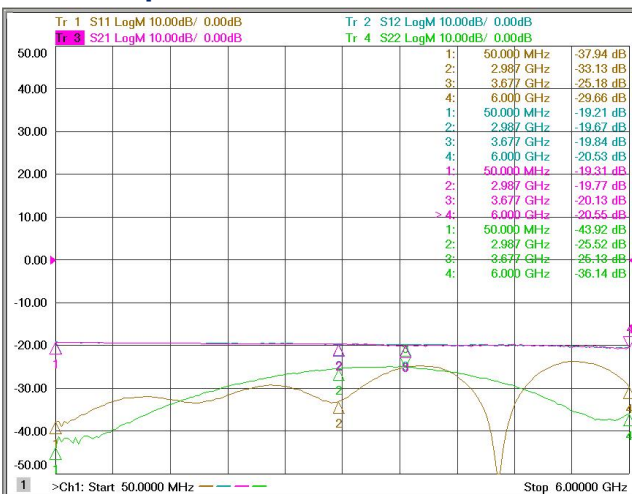

40dB Graph

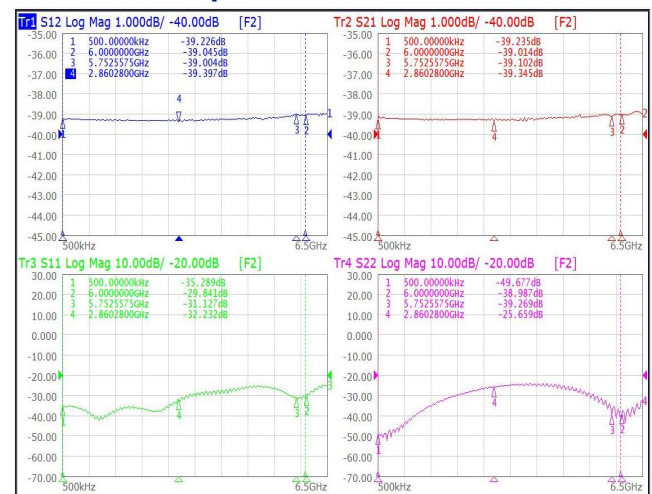



◆Use Attention:

1. Elastic contact is used at the contact point between the connector and the sleeve electrode;
 2. The inner hole of the radiator should match the diameter of the sleeve, and the tolerance should not be too large;
- Operation steps:
- A. Tighten one end of the connector with a thread to one end of the radiator;
 - B. Place the sleeve type attenuation plate into the internal hole of the radiator;
 - C. Then tighten the connector on the other end with a thread
 - D. Attention: Thread requires the use of thread sealant

◆Power De-rating:

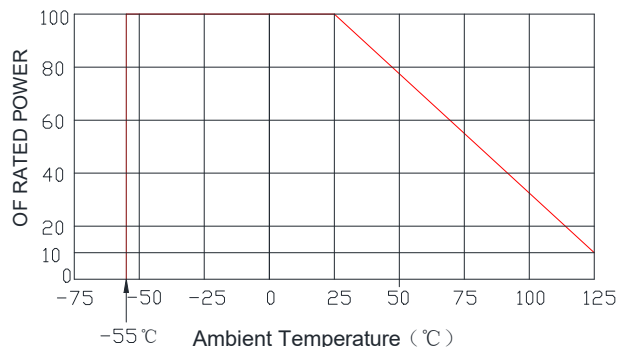

◆P/N Designation:

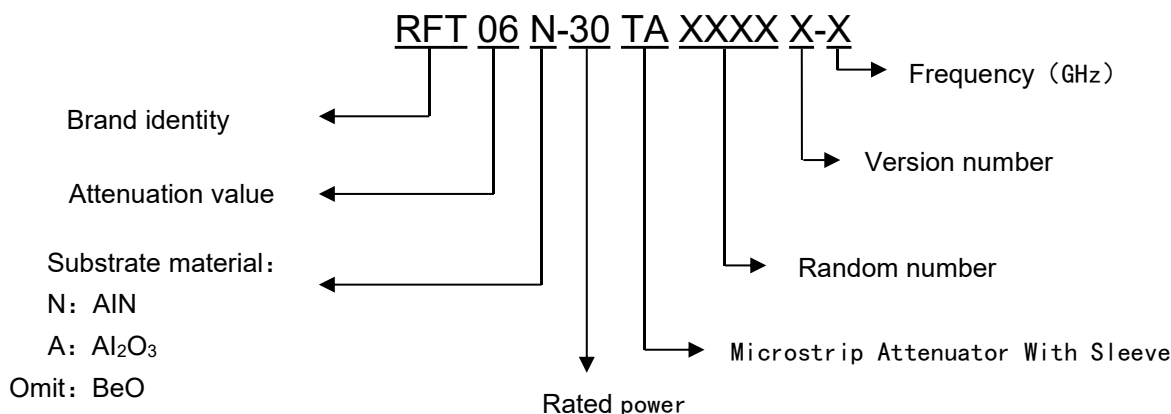

◆Notes:

- The sleeve and radiator need to be tightly connected to ensure heat dissipation.
- Good grounding is required to ensure S parameters.
- In order to meet the requirements of the drawings, it is necessary to install radiators of sufficient size.
- If necessary, increase air cooling or water cooling.
- The connection between the connector and the sleeve type attenuation electrode must use elastic contact.
- If the sleeve is marked with "IN", be sure to place one end of the IN on the input port, and if there is no label, it will be bidirectional.

◆Remarks:

- We can provide customized RF attenuators, RF resistors, coaxial dummy (termination) loads, and mismatched dummy (termination) loads.