



Coaxial Fixed Attenuator

Features and Electrical specifications:

Model	RFTXX-50RA3870-N-4 (XX=Attenuator Value)			
Frequency Range	DC~4.0GHz			
VSWR	1.20Max			
Power	50 W			
Impedance	50 Ω			
Attenuation	01-10dB	11-20dB	21-40dB	50/60dB
Attenuation Tolerance	±0.6dB	±0.8dB	±1.0dB	±1.2dB
Connector	N-J(M)/N-K(F)			
Dimension	Φ38×107mm			
Operating Temperature	-55 ~ +125°C (See de Power De-rating)			
Weight	About 180 g			
ROHS Compliant	Yes			

Outline Drawing (Unit: mm/inch):

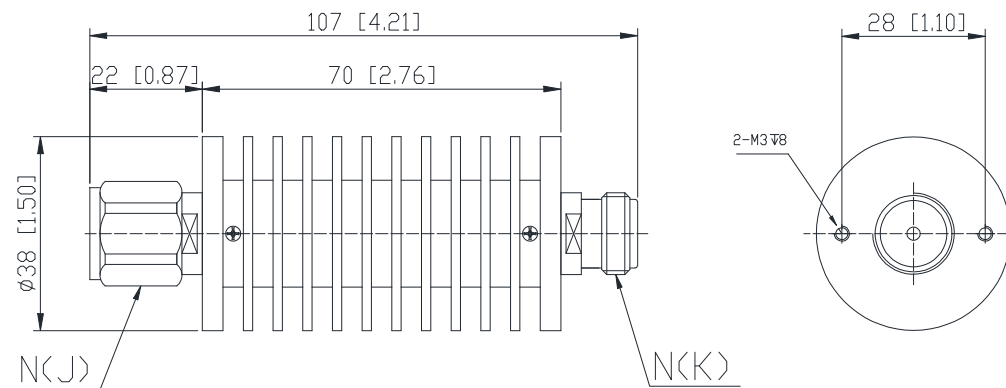

The connector could be N MM or FF



Naming rules:



Power De-rating:



Use attention:

- 1、 Dimensions Tolerance $\pm 3\%$;
- 2、 If necessary, the product shall be air-cooled for auxiliary heat dissipation ;
- 3、 Custom designs available of other special coaxial fixed attenuator ;
- 4、 Pay attention to the direction of the product during use and strictly prohibit reverse connection.