



Coaxial Fixed Attenuator

Features and Electrical specifications:

Model	RFTXX-10RA1528-SMA-8 (XX=Attenuator Value)		
Frequency Range	DC~8.0GHz		
VSWR	1.30 Max		
Power	10 W		
Impedance	50 Ω		
Attenuation	1-10dB	11-20dB	21-30、40dB
Attenuation Tolerance	±0.6dB	±0.8dB	±1.0dB
Connector	SMA-J(M)/SMA-K(F)		
Dimension	Φ15.5×46.7mm		
Operating Temperature	-55 ~ +125°C (See de Power De-rating)		
Weight	About 10 g		
ROHS Compliant	Yes		

Outline Drawing (Unit: mm/inch):

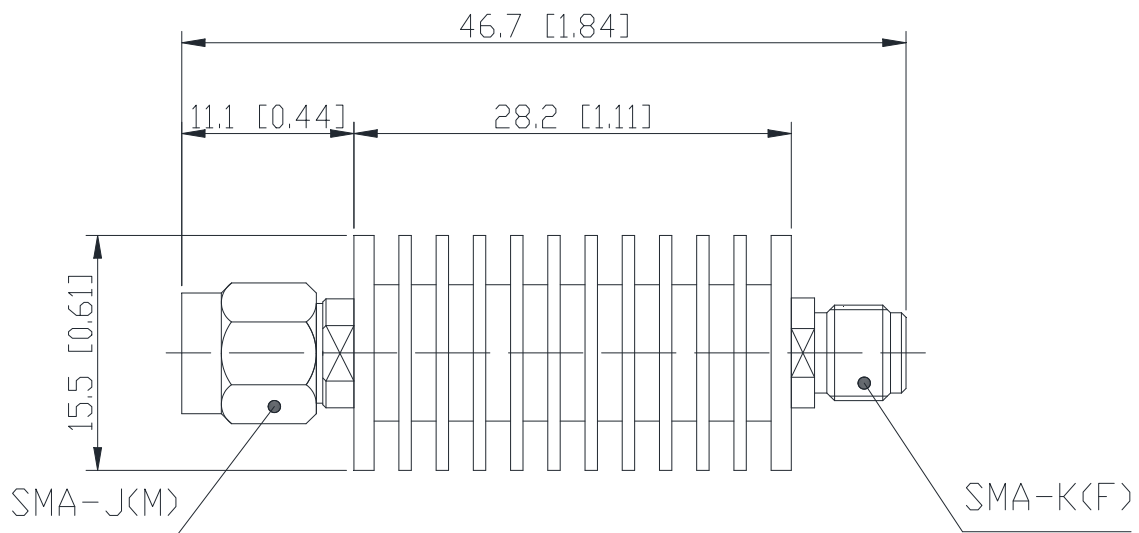

The connector could be changed to SMA-M to SMA-M or SMA-F to SMA-F



Naming rules:



Power De-rating:



Use attention:

- 1、 Dimensions Tolerance $\pm 3\%$;
- 2、 If necessary, the product shall be air-cooled for auxiliary heat dissipation ;
- 3、 Custom designs available of other special coaxial fixed attenuator ;
- 4、 Pay attention to the direction of the product during use and strictly prohibit reverse connection.