



Low Pass Filter

Features and Electrical specifications:

Model	LPF-DCM1600A-S
Frequency Range	DC-1600 MHz
Insertion Loss	≤2.0dB
Rejection	≥40dB@1696-11000MHz
VSWR	2.0 Max
Rated Power	20 W
Impedance	50 Ω
Connector Type	SMA-F (K)
Dimension	94.0x40.0x27.0mm
Surface Finishing	Black Painting
Operating Temperature	Ordinary Temperature
Storage Temperature	-55 ~ +85°C

Outline Drawing (Unit: mm):

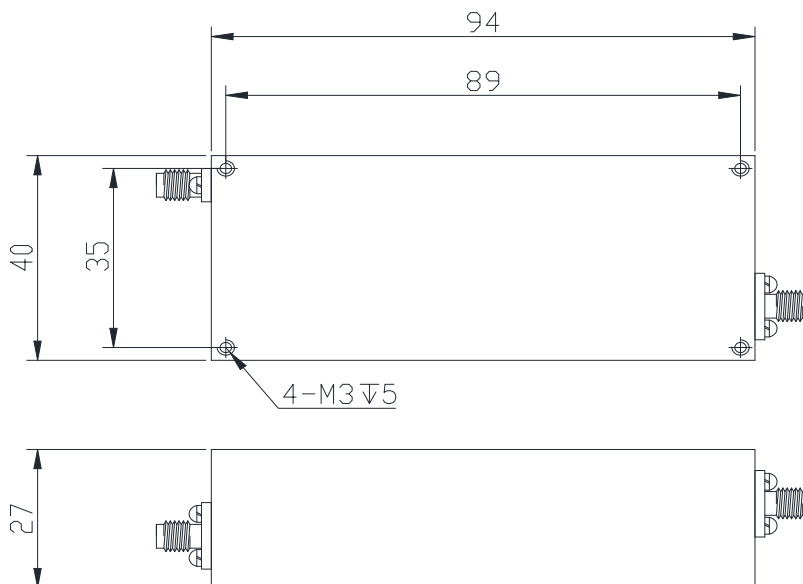
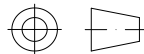

RFTYT Technology Co., LTD.

<http://www.rftyt.com>

E-mail: jackson@rftyt.com zqc7708@rftyt.com

TEL: +86-13088268828 FAX: +86-816-2846565

218# Wenwu Middle Road, Jinkai District, Mianyang, Sichuan Province China

Ready For Tackling Your Trouble