



Directional Coupler

Features and Electrical specifications:

Model	CP10-F1573-S/1-4GHz
Frequency Range	1~4GHz
Insertion Loss	0.5dB (Excluding 0.45dB coupling loss)
Nominal Coupling	10±1dB
Coupling Sensitivity	≤±0.7dB
Directivity	≥20dB
VSWR	1.20 Max
Rated Power	50W
Impedance	50 Ω
Connector Type	SMA-F
Dimension	73x15x11 mm
Surface Finishing	Grey Painting
Operating Temperature	-55 ~ +85°C
ROHS Compliant	Yes

Outline Drawing (Unit: mm):

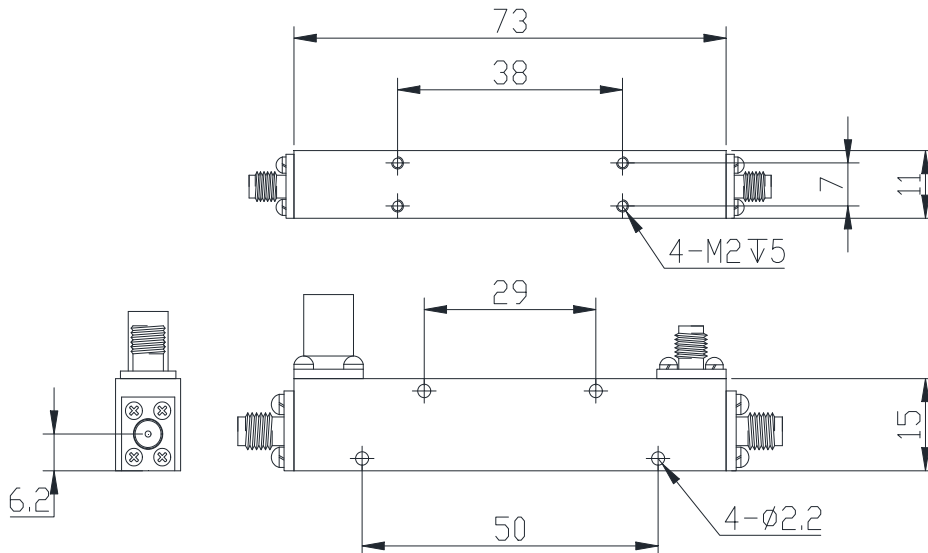
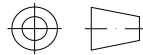

RFTYT Technology Co., LTD.

<http://www.rftyt.com>

E-mail : jackson@rftyt.com zqc7708@rftyt.com

TEL: +86-13088268828 FAX: +86-816-2846565

218# Wenwu Middle Road, Jinkai District, Mianyang, Sichuan Province China

Ready For Tackling Your Trouble