



High Pass Filter

Features and Electrical specifications:

Model	HPF-2G18A-S
Frequency Range	2-18 GHz
Insertion Loss	$\leq 2.0\text{dB}@2000-2250\text{MHz}$ $\leq 1.0\text{dB}@2250-18000\text{MHz}$
Rejection	$\geq 45\text{dB}@DC-1800\text{MHz}$
VSWR	1.8 Max
Rated Power	20 W
Impedance	50 Ω
Connector Type	SMA-F
Dimension	50.0x28.0x10.0mm
Surface Finishing	Black Painting
Operating Temperature	Ordinary temperature
Storage Temperature	-55 ~ +85°C

Outline Drawing (Unit: mm):

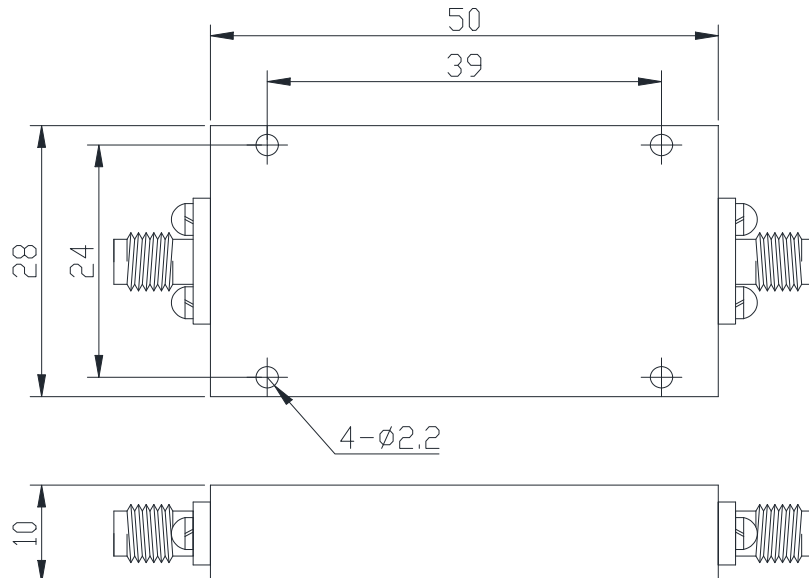
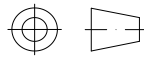

RFTYT Technology Co., LTD.

<http://www.rfyt.com>

E-mail: jackson@rfyt.com zqc7708@rfyt.com

TEL: +86-13088268828 FAX: +86-816-2846565

218# Wenwu Middle Road, Jinkai District, Mianyang, Sichuan Province China

Ready For Tackling Your Trouble