



2 Way Power Divider

Features and Electrical specifications:

Model	PD02-F3056-S/0.5-8GHz	
Frequency Range	0.5-8 GHz	
Insertion Loss	≤1.5dB	
Isolation	20 dB min	
VSWR	Input: 1.5 Max	Output: 1.3 Max
Amplitude Unbalance	±0.3 dB	
Phase Unbalance	± 3°	
Rated Power	Forward Power: 30 W	Reverse Power: 1 W
Impedance	50 Ω	
Connector Type	SMA-F	
Dimension	30.0X56.0X10.0 mm	
Surface Finishing	Grey Painting	
Operating Temperature	-45 ~ +85°C	
ROHS Compliant	Yes	

Outline Drawing (Unit: mm):

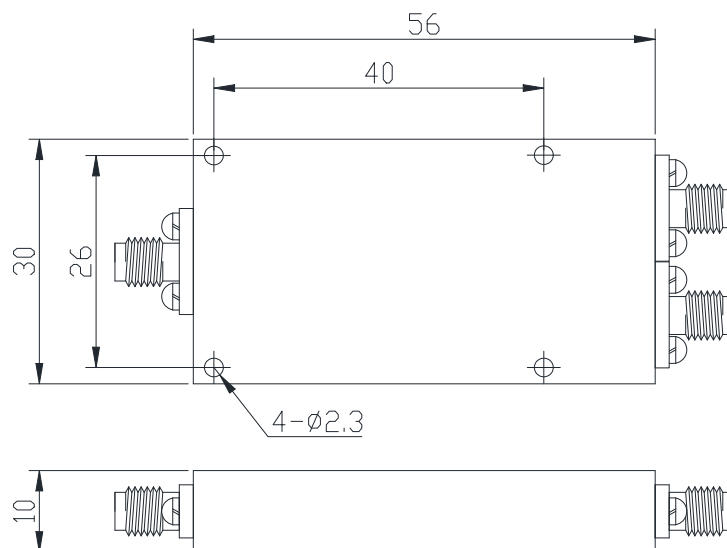
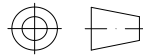

RFTYT Technology Co., LTD.

<http://www.rftyt.com>

E-mail : jackson@rftyt.com zqc7708@rftyt.com

TEL: +86-13088268828 FAX: +86-816-2846565

218# Wenwu Middle Road, Jinkai District, Mianyang, Sichuan Province China

Ready For Tackling Your Trouble