



3 Way Power Divider

Features and Electrical specifications:

Model	PD03-F7212-S/698-3800MHz
Frequency Range	698-3800 MHz
Insertion Loss	≤1.2dB
Split loss	4.8dB
Isolation	≥20dB
VSWR	1.3 Max
Rated Power	50 W
Impedance	50 Ω
Connector Type	SMA-F
Waterproof Grade	IP65
Relative Humidity	≤95%
Surface Finishing	Black Painting
Operating Temperature	-20 ~ +60°C
ROHS Compliant	Yes

Outline Drawing (Unit: mm):

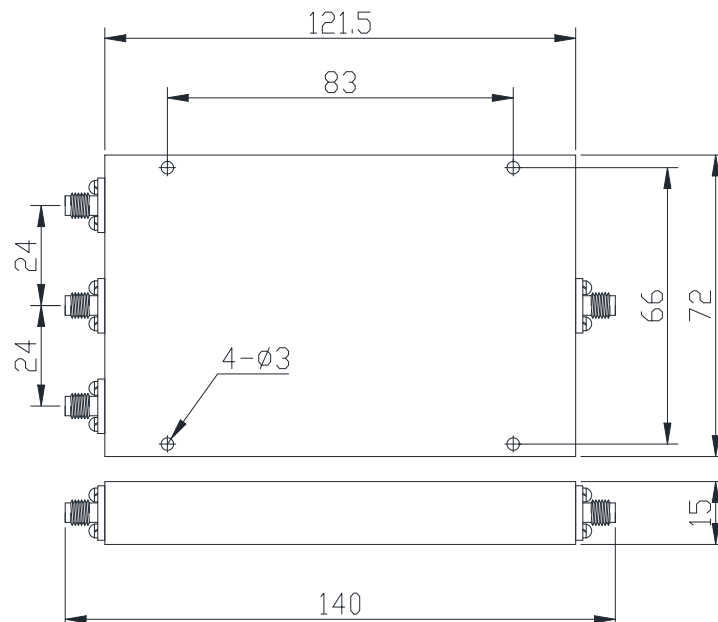

RFTYT Technology Co., LTD.

<http://www.rftyt.com>

E-mail : jackson@rftyt.com zqc7708@rftyt.com

TEL: +86-13088268828 FAX: +86-816-2846565

218# Wenwu Middle Road, Jinkai District, Mianyang, Sichuan Province China

Ready For Tackling Your Trouble