



4 Way Power Divider

Features and Electrical specifications:

Model	PD04-F7215-S/0.5-18GHz	
Frequency Range	0.5-18 GHz	
Insertion Loss	≤4.0dB	
Isolation	16 dB Min	
VSWR	Input: 1.70 Max	Output: 1.50 Max
Amplitude Unbalance	±0.5 dB	
Phase Unbalance	± 8°	
Rated Power	Forward Power: 20 W	Reverse Power: 1 W
Impedance	50 Ω	
Connector Type	SMA-F	
Dimension	154.0X72.0X10.0 mm	
Surface Finishing	Grey Painting	
Operating Temperature	-45 ~ +85°C	
ROHS Compliant	Yes	

Outline Drawing (Unit: mm):

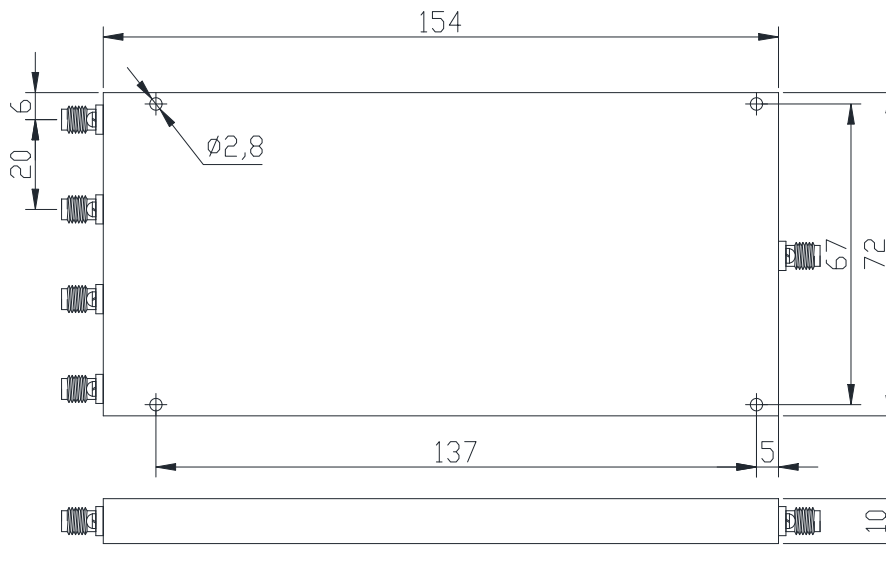

RFTYT Technology Co., LTD.

<http://www.rftyt.com>

E-mail : jackson@rftyt.com zqc7708@rftyt.com

TEL: +86-13088268828 FAX: +86-816-2846565

218# Wenwu Middle Road, Jinkai District, Mianyang, Sichuan Province China

Ready For Tackling Your Trouble