



## Leaded Resistor

### Features and Electrical specifications:

Model	RFTXX-100RM1010
Power	100 W
Resistance	XX $\Omega$ ~ (10-1500 $\Omega$ Customizable)
Resistance Tolerance	$\pm 5\%$
Capacitance	5.6 PF@50 $\Omega$
Temperature Coefficient	<150ppm/ $^{\circ}$ C
Substrate	BeO
Cover	AL <sub>2</sub> O <sub>3</sub>
Lead	Copper silver plating
Resistive Element	Thick Film
Operating Temperature	-55 to +150 $^{\circ}$ C (See de Power De-rating)

Outline Drawing (Unit: mm) :

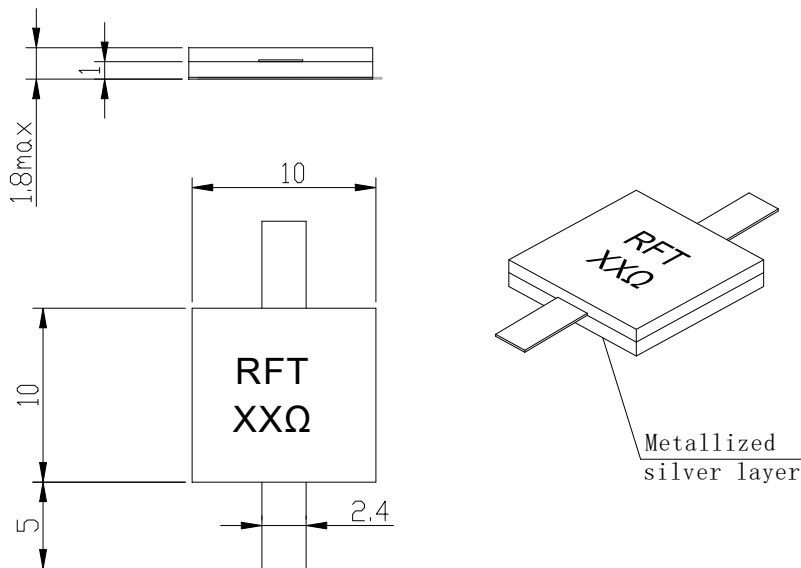
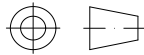

The length of lead wire can meet the customer's requirements

**RFTYT Technology Co., LTD.**

<http://www.rftyt.com>

E-mail: [jackson@rftyt.com](mailto:jackson@rftyt.com)

[zqc7708@rftyt.com](mailto:zqc7708@rftyt.com)

TEL: +86-13088268828

FAX: +86-816-2846565

218# Wenwu Middle Road, Jinkai District, Mianyang, Sichuan Province China

**Ready For Tackling Your Trouble**



Suggested Stress Relief Methods:



Power De-rating:



Reflow Profile:

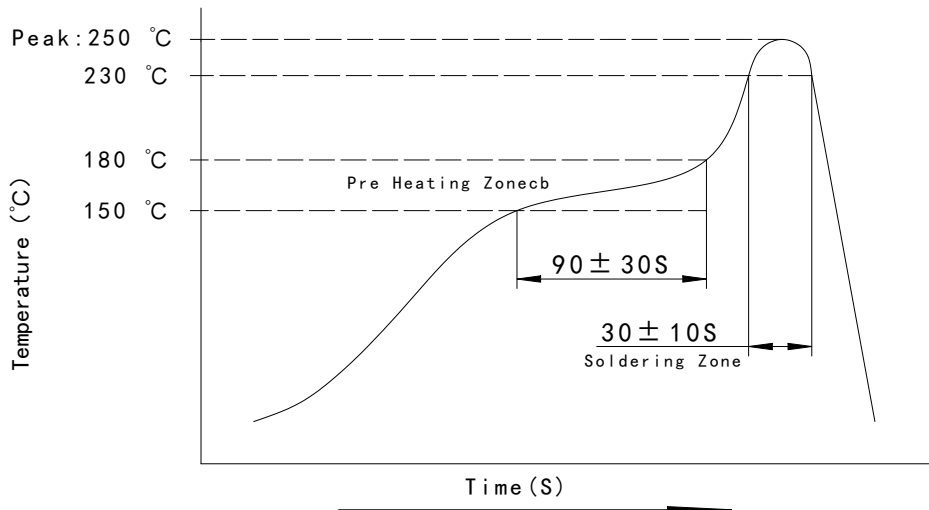

P/N Designation:

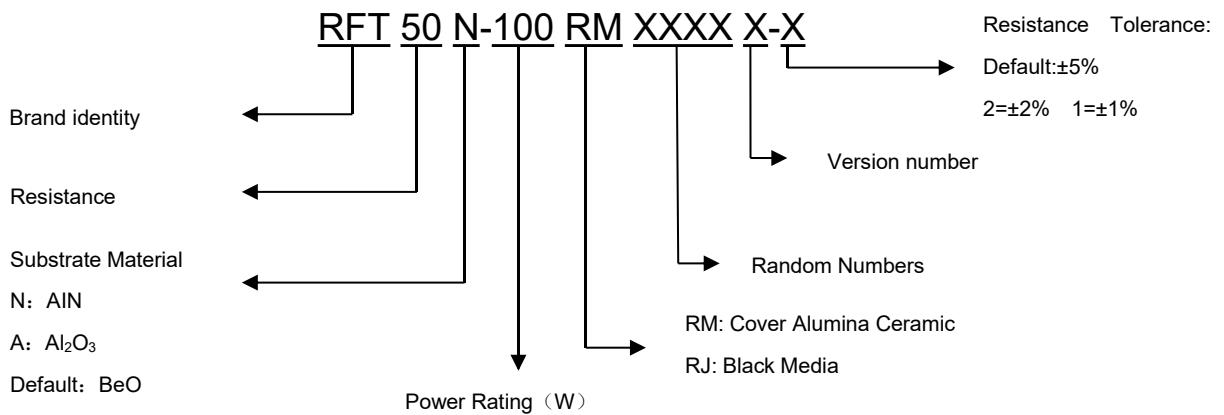



#### Use attention:

■ After the storage period of newly purchased components exceeds 6 months, attention should be paid to weldability before use. Storage is recommended for storage after vacuum packaging.

■ Forming a small loop in the tab will act as a strain relief as the heat is dissipated.

■ The best heat conduction is required on the ground surface.

■ Manual welding lead out should be used at or less than 350 degrees of constant temperature solder iron, welding time controlled in 5 seconds.

■ In order to satisfy the drawings, it is necessary to install a large enough radiator. The metal surface and radiator need to be coated with a very thin layer of thermal conductive silicone grease.

■ If necessary, add air cooling or water cooling.

#### Explain:

■ Custom designs available RF Attenuators and RF Resistors and RF Terminations.