



Leaded Attenuator

◆Features and Electrical specifications:

Model	RFTXX-150AM1010-6 (XX=Attenuation value)			
Impedance	50 Ω			
Frequency Range	DC~6.0GHz			
VSWR	1.25 max			
Rated Power	150 W			
Attenuation Value	01-10dB	15、17、20、21dB	19dB	23、24dB
Attenuation Tolerance	±0.8dB	+0.5/-1.5dB	+0.5/-2.0dB	±1.0dB
Temperature coefficient	<150ppm/°C			
Substrate Material	BeO			
Porcelain Hat Material	Al ₂ O ₃			
Lead	99.99% Sterling Silver			
Resistance Technology	Thick Film			
Operating Temperature	-55 to +150°C (See de Power De-rating)			

◆Outline Drawing (Unit: mm/inch):

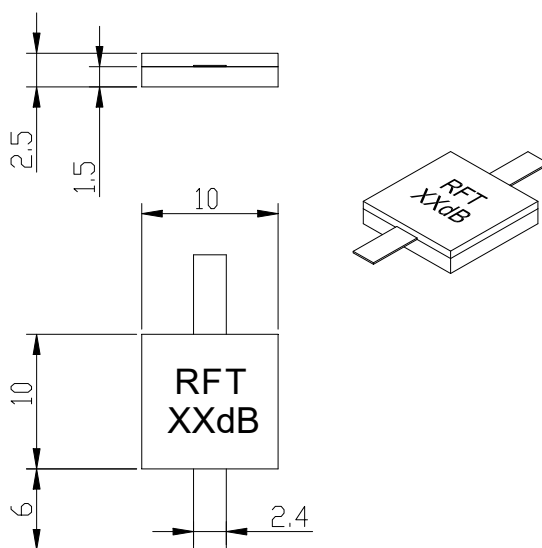

Lead length can be customized according to customer requirements
Dimensional tolerance: 5% unless otherwise stated

RFTYT Technology Co., LTD.

<http://www.rftyt.com>

E-mail: Jackson@rftyt.com

Cerman.wu@rftyt.com

TEL: +86-13088268828

FAX: +86-816-2846565

218# Wenwu Middle Road, Jinkai District, Mianyang, Sichuan Province China

Ready For Tackling Your Trouble



Typical Performance:

1dB Graph

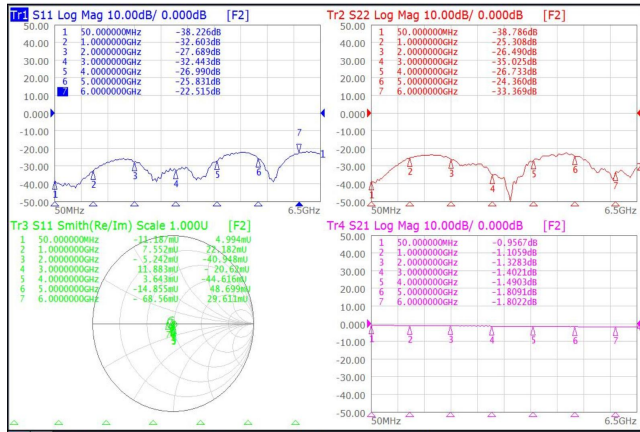

3dB Graph

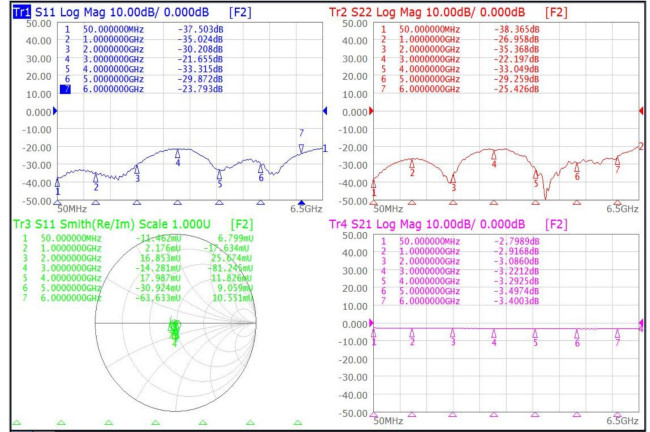

10dB Graph

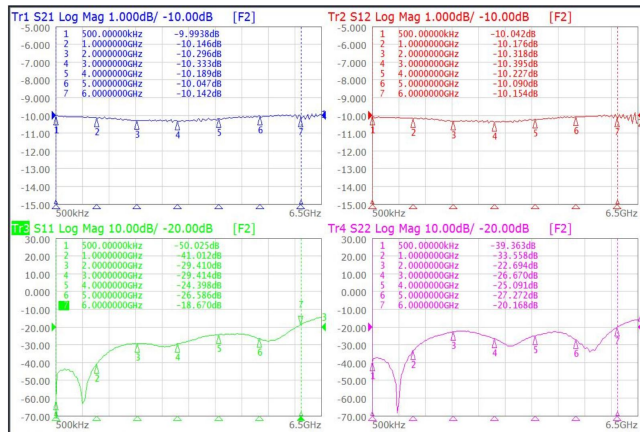

17dB Graph

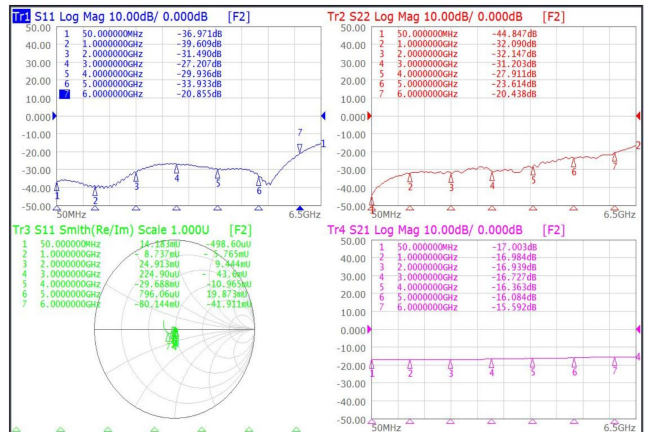

20dB Graph

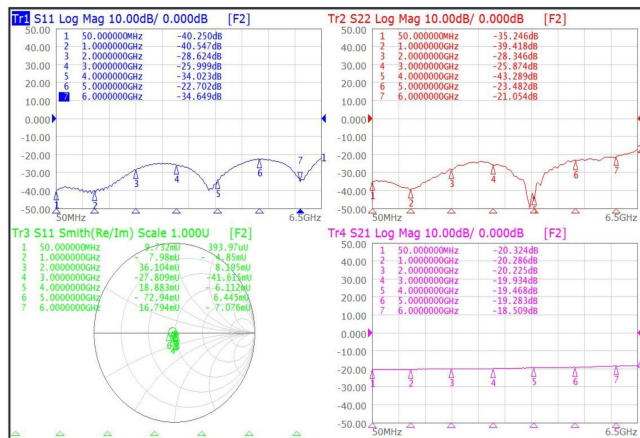

24dB Graph

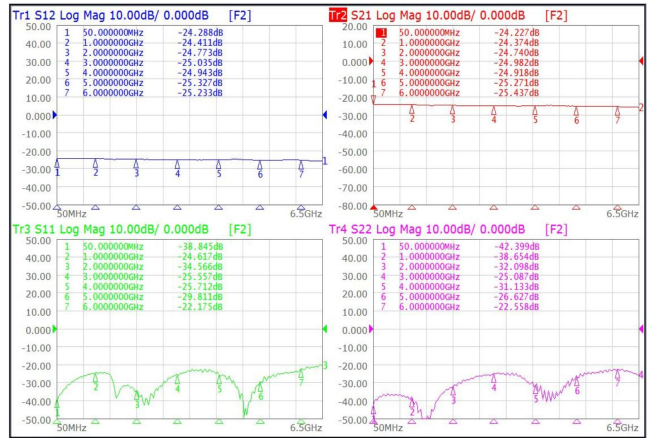



◆Installation Method:

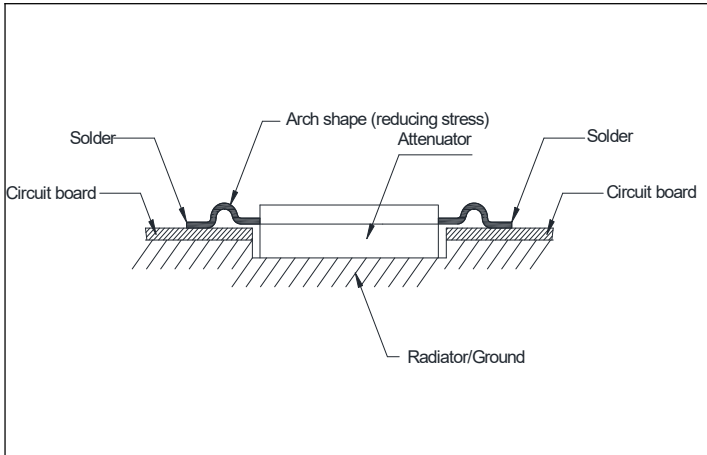

◆Power De-rating:

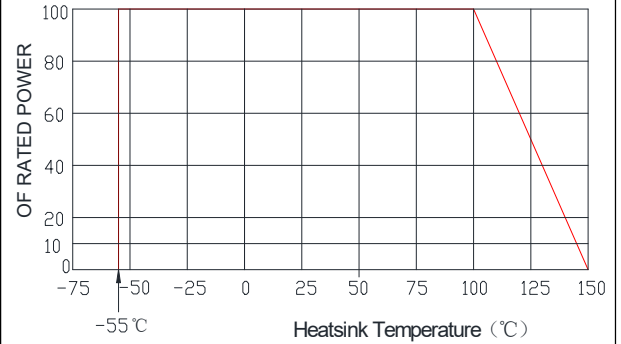

◆Reflow Profile:

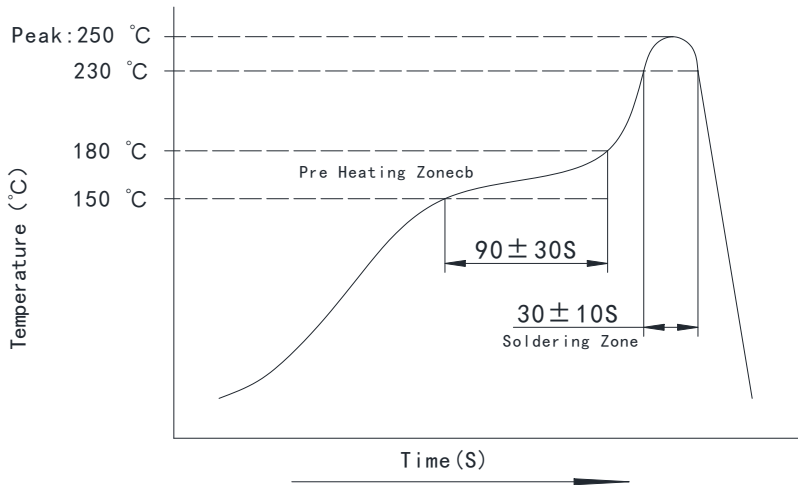

◆P/N Designation:

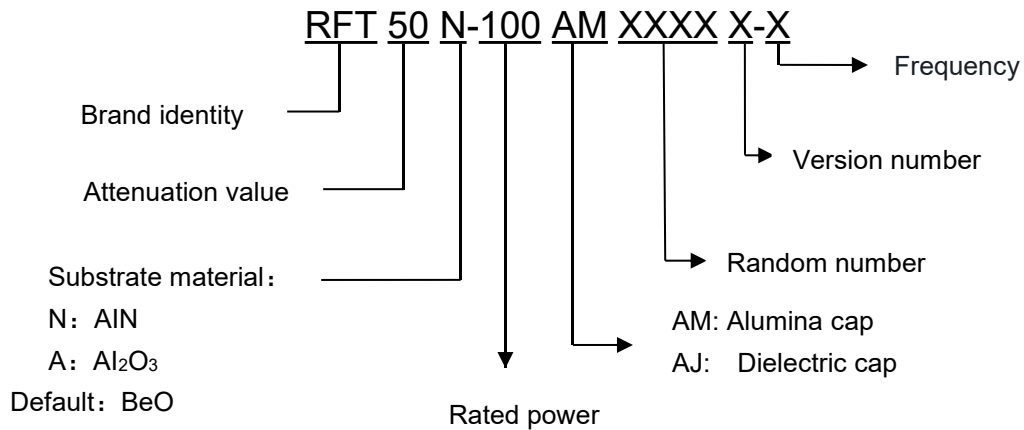



◆ **Notice:**

- After the storage period of newly purchased parts exceeds 6 months, attention should be paid to weldability before use. It is recommended to store in vacuum packaging.
- The ground needs optimal heat transfer.
- The manual welding lead should be used under a constant temperature soldering iron of no more than 350 degrees, and the welding time should be controlled within 5 seconds.
- In order to meet the drawing requirements, it is necessary to install a sufficiently large radiator. Metal surfaces and radiators need to be coated with a very thin layer of thermal grease.
- If necessary, add air or water cooling.

◆ **Instructions:**

- Custom designed RF attenuators, RF resistors and RF terminals are available.