



Directional Coupler

Features and Electrical specifications:

Model	CP30-F1543-S/2-18GHz
Frequency Range	2~18GHz
Insertion Loss	≤0.7dB
Nominal Coupling	30±1dB
Coupling Sensitivity	±1.0dB
Directivity	20dB
VSWR	1.50 Max
Rated Power	50W
Impedance	50 Ω
Connector Type	SMA-F
Dimension	43x15x11 mm
Surface Finishing	Grey Painting
Operating Temperature	-55 ~ +85°C
ROHS Compliant	Yes

Outline Drawing (Unit: mm):

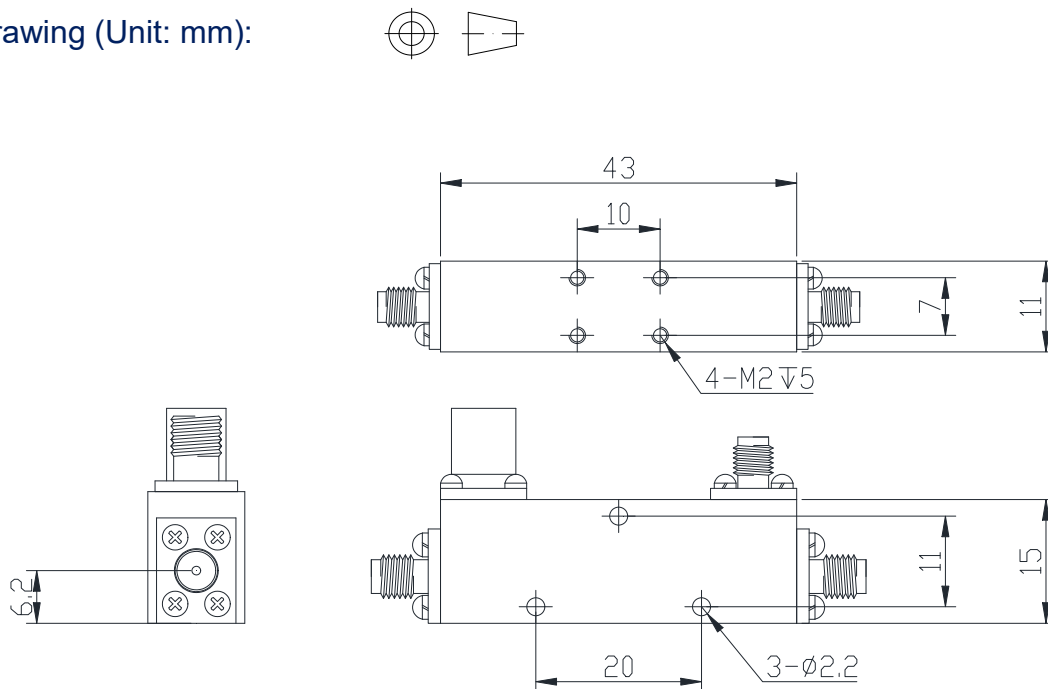

RFTYT Technology Co., LTD.

<http://www.rfyt.com>

E-mail : jackson@rfyt.com zqc7708@rfyt.com

TEL: +86-13088268828 FAX: +86-816-2846565

218# Wenwu Middle Road, Jinkai District, Mianyang, Sichuan Province China

Ready For Tackling Your Trouble