



4 Way Power Divider

Features and Electrical specifications:

Model	PD04-R2460-N/2400-6000MHz
Frequency Range	2400-6000 MHz
Split Loss	6.0 dB
Insertion Loss	≤0.35 dB
VSWR	≤1.30
Rated Power	300 W
Impedance	50 Ω
Connector Type	N-F
Dimension	235.4X60.4X25 mm
Surface Finishing	Black Painting
Operating Temperature	-20 ~ +70°C
Weight	0.3 Kg
ROHS Compliant	Yes

Outline Drawing (Unit: mm):

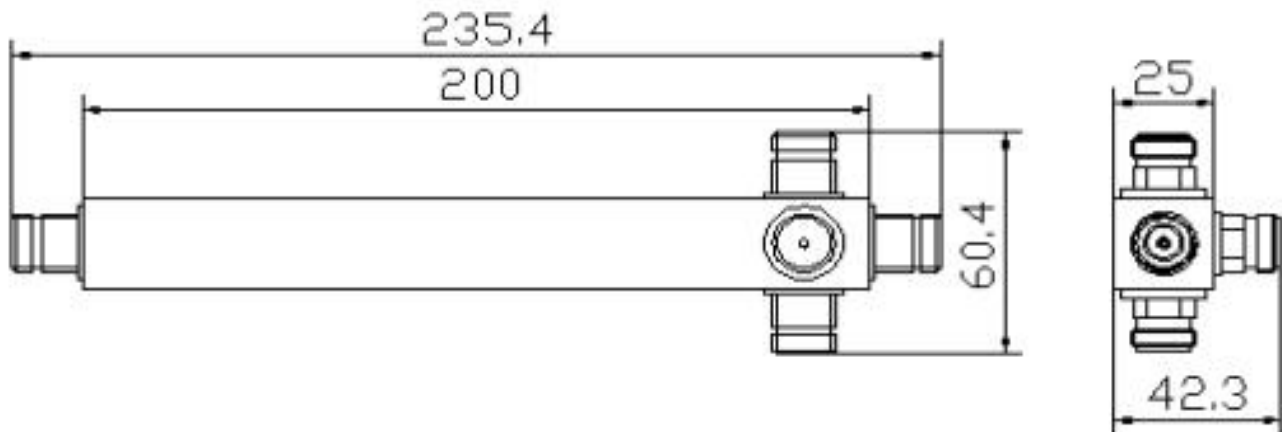

RFTYT Technology Co., LTD.

<http://www.rfyt.com>

E-mail : jackson@rfyt.com zqc7708@rfyt.com

TEL: +86-13088268828 FAX: +86-816-2846565

218# Wenwu Middle Road, Jinkai District, Mianyang, Sichuan Province China

Ready For Tackling Your Trouble