



Coaxial Fixed Termination

Features and Electrical specifications:

Model	CT-02W-RA0910-SJ-8G
Frequency Range	DC~8.0GHz
VSWR	1.20 Max
Power	2W
Impedance	50 Ω
Connector Type	SMA-M (J)
Dimension	$\Phi 9.0 \times 21$ mm
Operating Temperature	-55 ~ +125°C (See de Power De-rating)
Weight	6.5 g
ROHS Compliant	Yes

Outline Drawing (Unit: mm/inch):

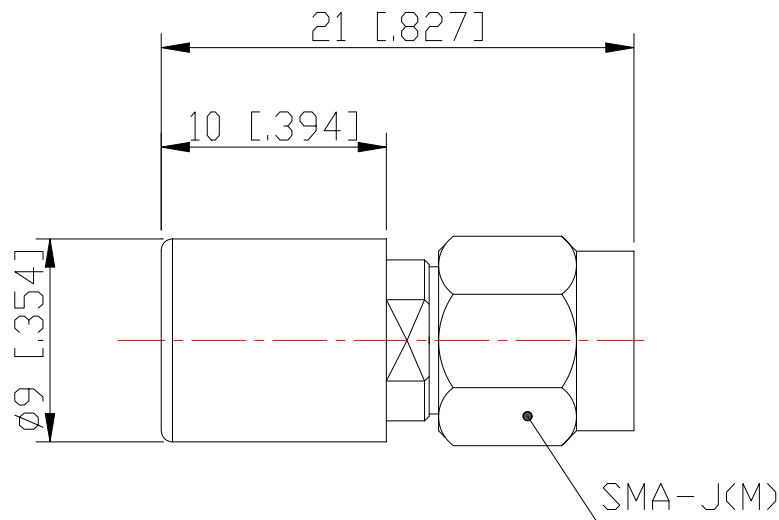

RFTYT Technology Co., LTD.

<http://www.rftyt.com>

E-mail: jackson@rftyt.com zqc7708@rftyt.com

TEL: +86-13088268828 FAX: +86-816-2846565

218# Wenwu Middle Road, Jinkai District, Mianyang, Sichuan Province China

Ready For Tackling Your Trouble



Use attention:

- 1、 Dimensions Tolerance $\pm 3\%$;
- 2、 If necessary, the product shall be air-cooled for auxiliary heat dissipation;
- 3、 Custom designs available of other special Coaxial Terminations;
- 4、 Pay attention to the direction of the product during use and strictly prohibit reverse connection。

Power De-rating:



P/N Designation:

