



## Coaxial Fixed Termination

### Features and Electrical specifications:

Model	CT-05W-RA2030-4310J-3G
Frequency Range	DC~3.0GHz
VSWR	1.20 Max
Power	5W
Impedance	50 Ω
Connector Type	4.3-10-M (J)
Dimension	Φ20×30mm
Operating Temperature	-55 ~ +125°C (See de Power De-rating)
Weight	90 g
ROHS Compliant	Yes

Outline Drawing (Unit: mm/inch):

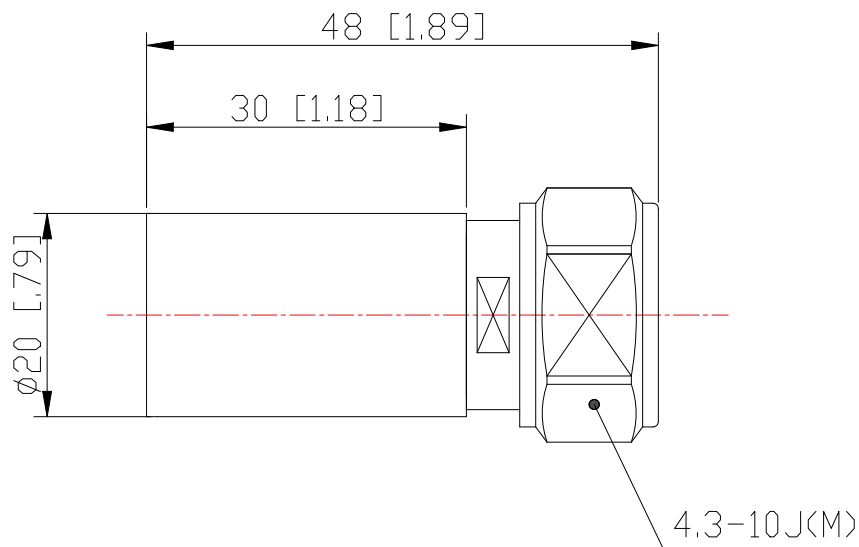

**RFTYT Technology Co., LTD.**

<http://www.rftyt.com>

E-mail: [jackson@rftyt.com](mailto:jackson@rftyt.com)      [zqc7708@rftyt.com](mailto:zqc7708@rftyt.com)

TEL: +86-13088268828      FAX: +86-816-2846565

218# Wenwu Middle Road, Jinkai District, Mianyang, Sichuan Province China

**Ready For Tackling Your Trouble**



Use attention:

- 1、 Dimensions Tolerance  $\pm 3\%$ ;
- 2、 If necessary, the product shall be air-cooled for auxiliary heat dissipation;
- 3、 Custom designs available of other special Coaxial Terminations;
- 4、 Pay attention to the direction of the product during use and strictly prohibit reverse connection。

Power De-rating:



P/N Designation:

