



## Coaxial Fixed Termination

### Features and Electrical specifications:

|                       |                                       |
|-----------------------|---------------------------------------|
| Model                 | CT-05W-RA2030-DINJ-4G                 |
| Frequency Range       | DC~4.0GHz                             |
| VSWR                  | 1.25 Max                              |
| Power                 | 5W                                    |
| Impedance             | 50 $\Omega$                           |
| Connector Type        | DIN-M (J)                             |
| Dimension             | $\Phi 20 \times 30$ mm                |
| Operating Temperature | -55 ~ +125°C (See de Power De-rating) |
| Weight                | 100 g                                 |
| ROHS Compliant        | Yes                                   |

Outline Drawing (Unit: mm/inch):

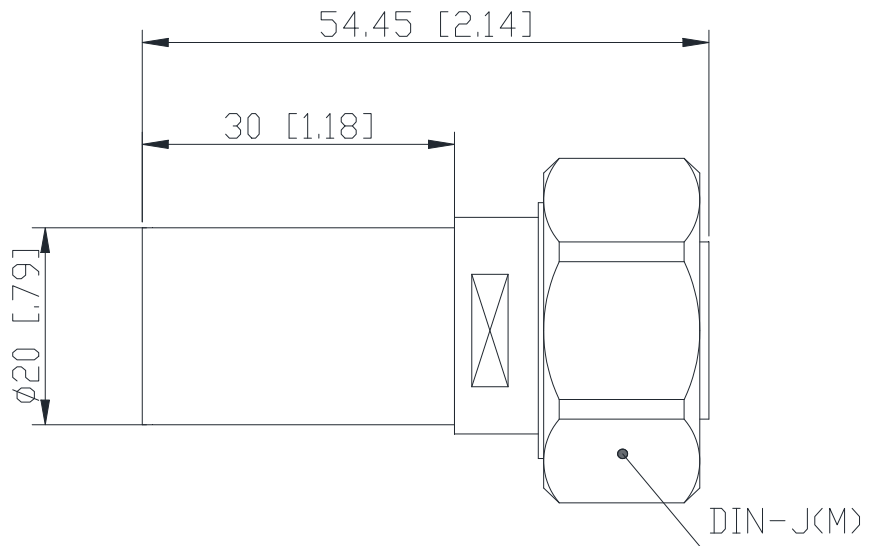

**RFTYT Technology Co., LTD.**

<http://www.rftyt.com>

E-mail: [jackson@rftyt.com](mailto:jackson@rftyt.com)      [zqc7708@rftyt.com](mailto:zqc7708@rftyt.com)

TEL: +86-13088268828      FAX: +86-816-2846565

218# Wenwu Middle Road, Jinkai District, Mianyang, Sichuan Province China

**Ready For Tackling Your Trouble**



Use attention:

- 1、 Dimensions Tolerance  $\pm 3\%$ ;
- 2、 If necessary, the product shall be air-cooled for auxiliary heat dissipation;
- 3、 Custom designs available of other special Coaxial Terminations;
- 4、 Pay attention to the direction of the product during use and strictly prohibit reverse connection。

Power De-rating:



P/N Designation:

