



Coaxial Fixed Termination

Features and Electrical specifications:

Model	CT-05W-RA2030-DINK-4G
Frequency Range	DC~4.0GHz
VSWR	1.25 Max
Power	5W
Impedance	50 Ω
Connector Type	DIN-F (K)
Dimension	$\Phi 20 \times 30$ mm
Operating Temperature	-55 ~ +125°C (See de Power De-rating)
Weight	95 g
ROHS Compliant	Yes

Outline Drawing (Unit: mm/inch):

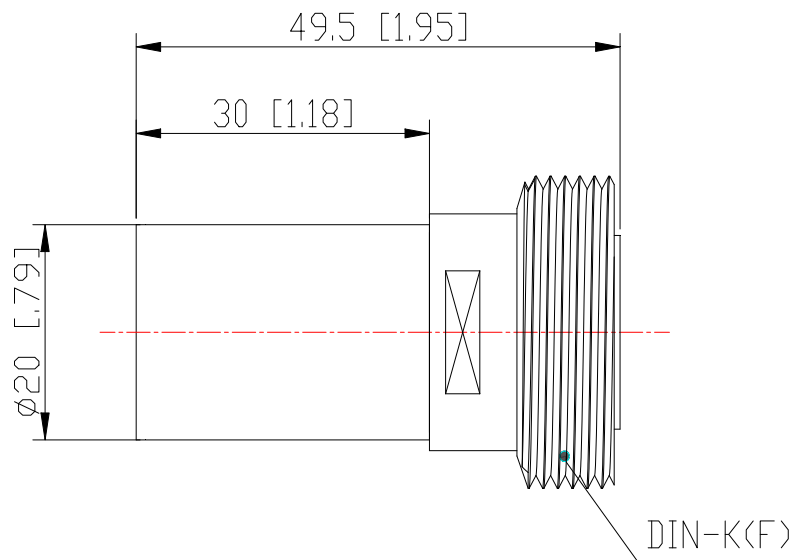



Use attention:

- 1、 Dimensions Tolerance $\pm 3\%$;
- 2、 If necessary, the product shall be air-cooled for auxiliary heat dissipation;
- 3、 Custom designs available of other special Coaxial Terminations;
- 4、 Pay attention to the direction of the product during use and strictly prohibit reverse connection。

Power De-rating:



P/N Designation:

