



Coaxial Fixed Termination

Features and Electrical specifications:

Model	Please check on outline drawing
Frequency Range	DC~18.0GHz
VSWR	1.30 Max
Power	10W
Impedance	50 Ω
Connector Type	SMA-F (K)
Dimension	Please check on outline drawing
Operating Temperature	-55 ~ +125°C (See de Power De-rating)
Weight	/ g
ROHS Compliant	Yes

Outline Drawing (Unit: mm/inch)

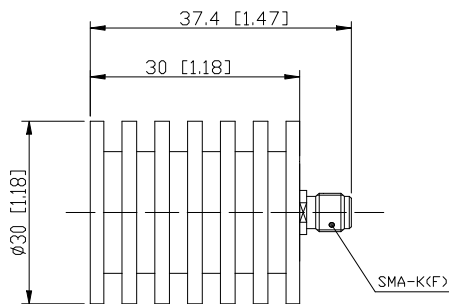
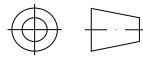

Model	Weight
CT-10W-RA3030-SK-18G	Around 40 g

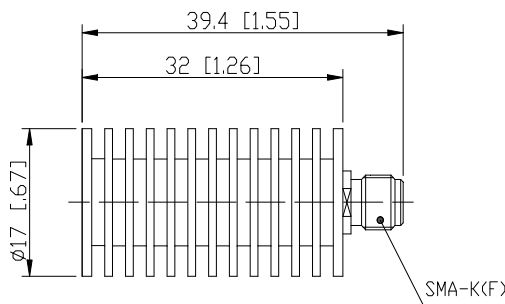

Model	Weight
CT-10W-RA1732-SK-18G	Around 16 g

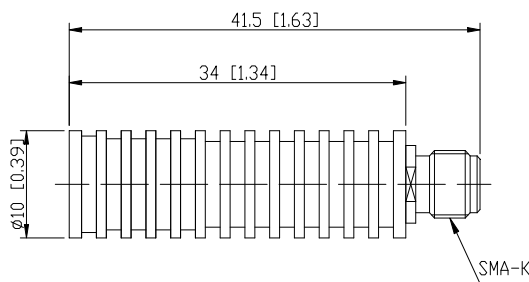

Model	Weight
CT-10W-RA1034-SK-18G	Around 9 g

RFTYT Technology Co., LTD.

<http://www.rftyt.com>

E-mail: jackson@rftyt.com zqc7708@rftyt.com

TEL: +86-13088268828 FAX: +86-816-2846565

218# Wenwu Middle Road, Jinkai District, Mianyang, Sichuan Province China

Ready For Tackling Your Trouble



Use attention:

- 1、 Dimensions Tolerance $\pm 3\%$;
- 2、 If necessary, the product shall be air-cooled for auxiliary heat dissipation;
- 3、 Custom designs available of other special Coaxial Terminations;
- 4、 Pay attention to the direction of the product during use and strictly prohibit reverse connection。

Power De-rating:

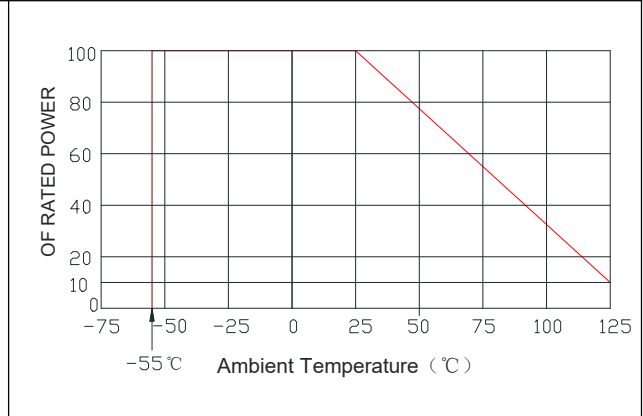

P/N Designation:

