



# Coaxial Fixed Termination

## Features and Electrical specifications:

Model	Please check on outline drawing
Frequency Range	DC~4.0GHz
VSWR	1.20 Max
Power	20W
Impedance	50 $\Omega$
Connector Type	SMA-M (J)
Dimension	Please check on outline drawing
Operating Temperature	-55 ~ +125°C (See de Power De-rating)
Weight	/ g
ROHS Compliant	Yes

## Outline Drawing (Unit: mm/inch)

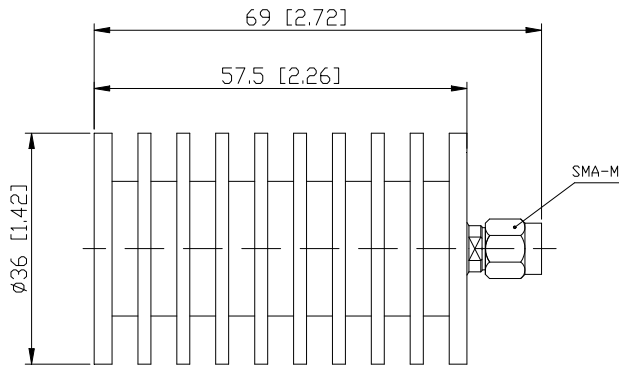

Model	Weight
CT-20W-RA3657-SJ-4G	Around 92g

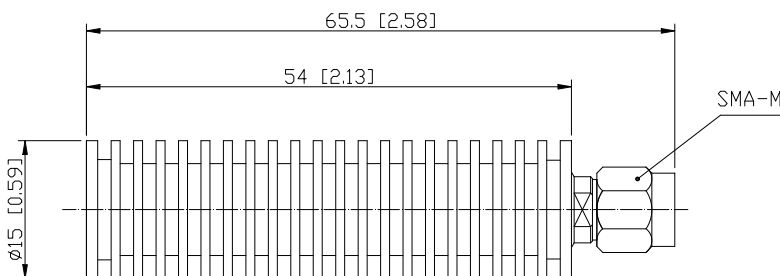

Model	Weight
CT-20W-RA1554-SJ-4G	Around 18 g



Use attention:

- 1、 Dimensions Tolerance  $\pm 3\%$ ;
- 2、 If necessary, the product shall be air-cooled for auxiliary heat dissipation;
- 3、 Custom designs available of other special Coaxial Terminations;
- 4、 Pay attention to the direction of the product during use and strictly prohibit reverse connection。

Power De-rating:



P/N Designation:

