



Coaxial Fixed Termination

Features and Electrical specifications:

Model	Please check on outline drawing
Frequency Range	DC~8.0GHz
VSWR	1.20 Max
Power	20W
Impedance	50 Ω
Connector Type	SMA-F (K)
Dimension	Please check on outline drawing
Operating Temperature	-55 ~ +125°C (See de Power De-rating)
Weight	/ g
ROHS Compliant	Yes

Outline Drawing (Unit: mm/inch)

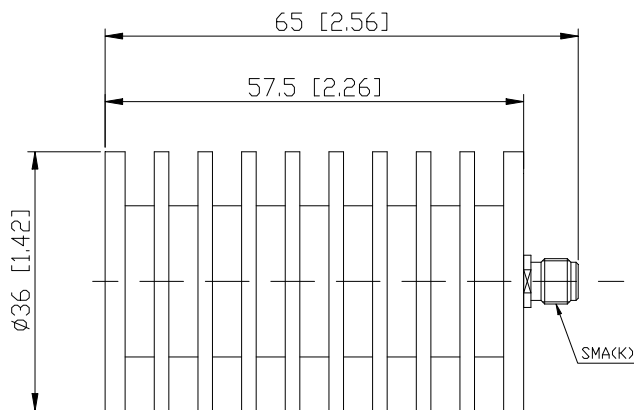

Model	Weight
CT-20W-RA3657-SK-8G	Around 92g

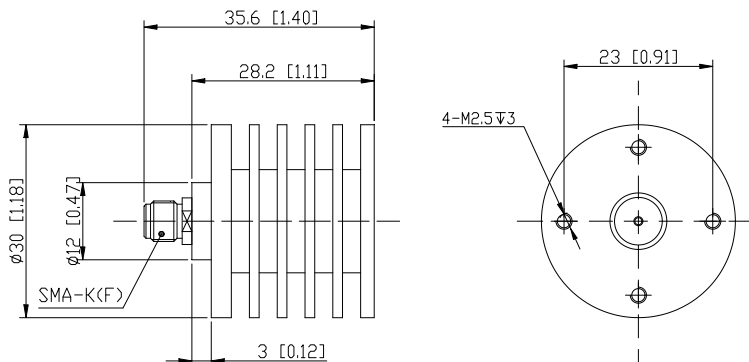

Model	Weight
CT-20W-RA3028-SK-8G	Around 37g



Use attention:

- 1、 Dimensions Tolerance $\pm 3\%$;
- 2、 If necessary, the product shall be air-cooled for auxiliary heat dissipation;
- 3、 Custom designs available of other special Coaxial Terminations;
- 4、 Pay attention to the direction of the product during use and strictly prohibit reverse connection。

Power De-rating:

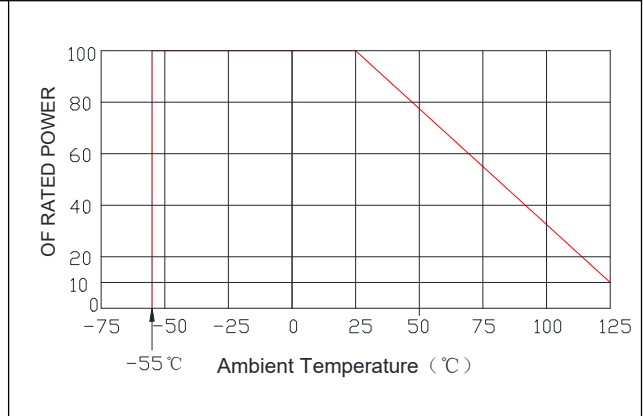

P/N Designation:

