



Coaxial Fixed Termination

Features and Electrical specifications:

Model	CT-30W-RA3857-NJ-3G
Frequency Range	DC~3.0GHz
VSWR	1.20 Max
Power	30W
Impedance	50 Ω
Connector Type	N-M (J)
Dimension	$\Phi 38 \times 57.2 \text{mm}$
Operating Temperature	-55 ~ +125°C (See de Power De-rating)
Weight	Around 148 g
ROHS Compliant	Yes

Outline Drawing (Unit: mm/inch):

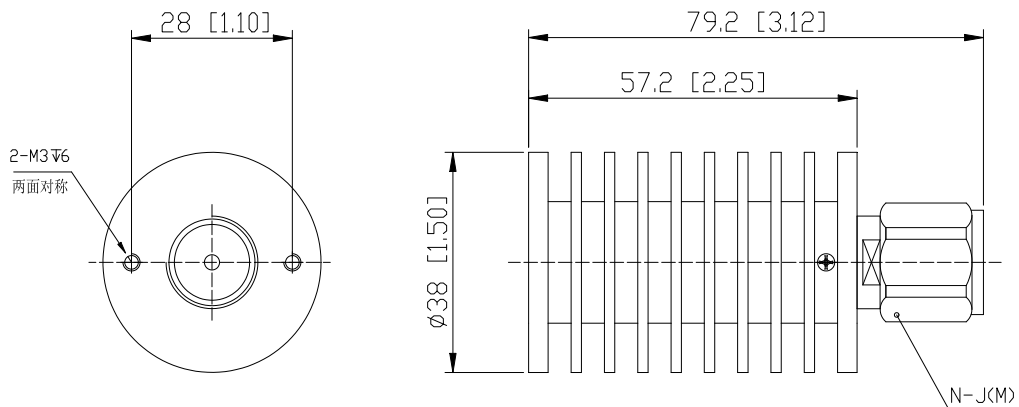



Use attention:

- 1、 Dimensions Tolerance $\pm 3\%$;
- 2、 If necessary, the product shall be air-cooled for auxiliary heat dissipation;
- 3、 Custom designs available of other special Coaxial Terminations;
- 4、 Pay attention to the direction of the product during use and strictly prohibit reverse connection。

Power De-rating:



P/N Designation:

