



Coaxial Fixed Termination

Features and Electrical specifications:

Model	CT-500W-FA8056-DINK-3G	
Frequency Range	DC~3.0GHz	
VSWR	1.35Max@ DC-50MHz	1.30Max@ 50MHz-3.0GHz
Power	500W	
Impedance	50 Ω	
Connector Type	DIN-F (K)	
Dimension	78×80×563mm	
Operating Temperature	-55 ~ +125°C (See de Power De-rating)	
Weight	Around 3.6 Kg	
ROHS Compliant	Yes	

Outline Drawing (Unit: mm/inch):

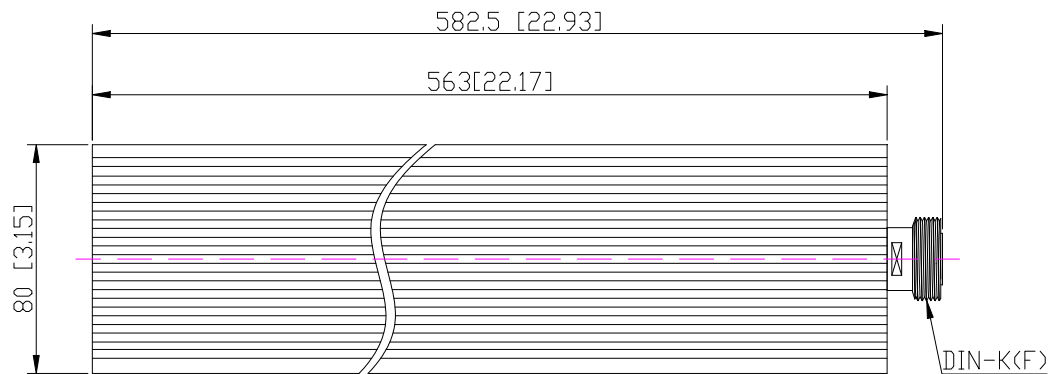
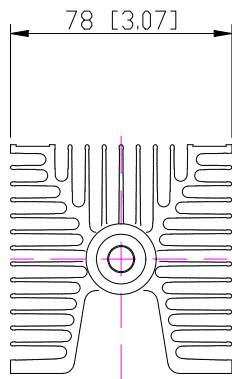

RFTYT Technology Co., LTD.

<http://www.rftyt.com>

E-mail: jackson@rftyt.com zqc7708@rftyt.com

TEL: +86-13088268828 FAX: +86-816-2846565

218# Wenwu Middle Road, Jinkai District, Mianyang, Sichuan Province China

Ready For Tackling Your Trouble



Use attention:

- 1、 Dimensions Tolerance $\pm 3\%$;
- 2、 If necessary, the product shall be air-cooled for auxiliary heat dissipation;
- 3、 Custom designs available of other special Coaxial Terminations;
- 4、 Pay attention to the direction of the product during use and strictly prohibit reverse connection。

Power De-rating:



P/N Designation:

